

# **OLYMPUS®**

**DIGITAL CAMERA**

**E-500**

**ADVANCED MANUAL**

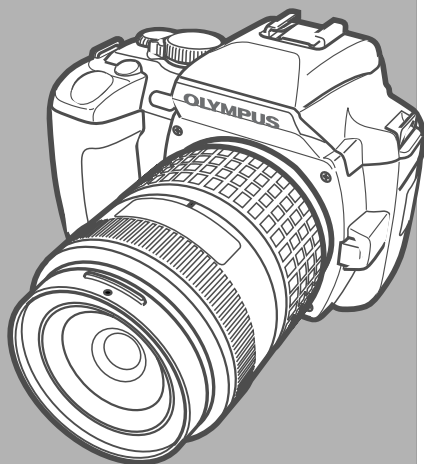

**Basic operations**

**Things to know before shooting**

**Selecting the right mode for shooting conditions**

**Various shooting functions**

**Focusing functions**

**Exposure, image and color**

**Playback**

**Customizing the settings/functions of your camera**

**Printing**

**Transferring images to a computer**

**Appendix**

**Information**

**Accessories**

- Thank you for purchasing an Olympus digital camera. Before you start to use your new camera, please read these instructions carefully to enjoy optimum performance and a longer service life.
- This manual explains advanced techniques such as shooting and playback functions, customizing functions or settings and transferring recorded images to a computer, etc.
- We recommend that you take test shots to get accustomed to your camera before taking important photographs.
- The screen and camera illustrations shown in this manual were produced during the development stages and may differ from the actual product.



# How to read the instruction pages

**AEL/AFL memo**

Pressing the AEL button toggles the AE lock between on and off.

- 1 Menu ▶ [1:] ▶ [AEL/AFL MEMO]
- 2 Use to select [ON] or [OFF].
- 3 Press the button.

Step through the menus in the order of ▶ ( P. 23).

This represents the arrow pad.

- 1 Press the **AF** (focus mode) button.
- 2 Use the control dial to select
  - S-AF / C-AF / MF / S-AF+MF / C-AF+MF
  - "S-AF (single AF) shooting" (P. 71)
  - "Simultaneous use of S-AF mode and MF mode (S-AF+MF)" (P. 71)
  - "C-AF (continuous AF) shooting" (P. 72)
  - "Manual focus (MF)" (P. 73)

This represents the control dial.

**Viewfinder**

	5-RF	5-RF : S-AF
	C-RF	C-RF : C-AF
	-F	-F : MF
	-F 5-RF	-F 5-RF : S-AF+MF
	-F C-RF	-F C-RF : C-AF+MF

**AF MODE**

**Control panel setting procedure**

**Menu setting procedure**

Shows alternative setting procedures.

This sample page is only for your reference. It may differ from the actual page in this manual.

## Indications used in this manual

	Important information on factors which may lead to a malfunction or operational problems. Also warns of operations that should be absolutely avoided.
	Useful information and hints that will help you get the most out of your camera.
	Reference pages describing details or related information.

# Table of Contents

How to use this manual	2
How to read the instruction pages	3
Safety precautions	10
<b>1 Basic operations</b>	
How to use the mode dial	18
Easy shooting modes	18
Advanced shooting modes	19
Control panel screen and function settings	20
Control panel screen display	20
How to make function settings	20
<b>2 Things to know before shooting</b>	
How to use card media	26
Selecting the card type	26
Formatting the card	26
If correct focus cannot be obtained	27
How to use focus lock	
(if the subject is not positioned in the center of the frame)	27
Selecting the record mode	29
Types of record modes	29
How to select the record mode	30
Setting the number of pixels and compression rate	30
<b>3 Selecting the right mode for shooting conditions</b>	
Shooting modes	33
Easy shooting modes	34
Advanced shooting modes	39
<b>P</b> : Program shooting	39
<b>A</b> : Aperture priority shooting	41
<b>S</b> : Shutter priority shooting	43
<b>M</b> : Manual shooting	45
Preview function	47
<b>4 Various shooting functions</b>	
Auto bracketing	49
Flash shooting	50
Flash mode	50
Manual flash	52
Setting the flash mode	54
Using the built-in flash	55
Flash intensity control	56
Flash bracketing	57
External electronic flashes (optional)	57
Using the external electronic flash	58
Super FP flash	60
Using commercially available flashes	60
Non-specified commercial flashes	61
Single-frame shooting/sequential shooting	62
Self-timer shooting	63
Remote control shooting	65



## 5 Focusing functions

AF frame selection . . . . .	69
Focus mode . . . . .	70
S-AF (single AF) shooting . . . . .	71
Simultaneous use of S-AF mode and MF mode (S-AF+MF) . . . . .	71
C-AF (continuous AF) shooting . . . . .	72
Simultaneous use of C-AF mode and MF mode (C-AF+MF) . . . . .	72
Manual focus (MF) . . . . .	73
MF bracketing . . . . .	74
AF illuminator . . . . .	75
Shutter release priority . . . . .	75

## 6 Exposure, image and color

Metering mode — Changing the metering system . . . . .	77
Exposure compensation — Varying the image brightness . . . . .	79
AE lock — Locking the exposure . . . . .	81
ISO — Setting the desired sensitivity to light . . . . .	82
AE bracketing . . . . .	83
White balance — Adjusting the color tone . . . . .	85
Setting the auto/preset white balance . . . . .	87
Setting the custom white balance . . . . .	89
Setting the one-touch white balance . . . . .	90
WB Compensation . . . . .	91
WB bracketing . . . . .	92
Picture mode . . . . .	93
Gradation . . . . .	94
Shading compensation . . . . .	94
Noise reduction . . . . .	95
Color space . . . . .	96
Anti-shock . . . . .	96

## 7 Playback

Single-frame playback . . . . .	98
Close-up playback . . . . .	99
Light box display . . . . .	100
Index display . . . . .	101
Calendar display . . . . .	102
Information display . . . . .	103
Slideshow . . . . .	106
Rotating images . . . . .	107
Playback on TV . . . . .	108
Editing still images . . . . .	109
Copying images . . . . .	113
Protecting images — Preventing accidental erasure . . . . .	114
Erasing images . . . . .	115
Single-frame erase . . . . .	115
All-frame erase . . . . .	115
Erasing selected frames . . . . .	116

## 8 Customizing the settings/functions of your camera

Custom reset setting	118
AEL/AFL mode	121
AEL/AFL memo	123
AEL metering	123
EV step	123
ISO step	124
ISO boost	124
ISO limit	124
Compensating all WB	125
Manual flash	125
Speed synchronization	126
Auto flash popup	126
Customizing the control dial's function	127
 button function	128
My Mode setting	128
Reset lens	129
Focus ring	129
Priority setting	129
Quick erase	130
Erasing RAW and JPEG files	130
File name	131
Rename file	132
Rec view - Checking the picture immediately after shooting	132
Setting the warning tone	133
Monitor brightness adjustment	133
Sleep timer	133
USB mode	134
Changing the display language	135
Selecting the video signal type before TV connection	135
Button timer	136
Auto power off	136
Start-up screen	137
Changing monitor color	137
Firmware	137
Setting the date/time	138

## 9 Printing

Print reservation (DPOF)	140
Flowchart for print reservation	141
Selecting the print reservation mode	142
Selecting pictures you want to print	142
Setting printing data	142
Confirming your print setting	143
Resetting print reservation	143

Direct printing (PictBridge) . . . . .	145
Connecting the camera to a printer . . . . .	146
Easy printing . . . . .	147
Flowchart for custom printing . . . . .	147
Selecting the print mode . . . . .	148
Setting the print paper items . . . . .	149
Selecting pictures you want to print . . . . .	149
Setting printing data . . . . .	150
Printing . . . . .	150
If an error code is displayed . . . . .	151
<b>10 Transferring images to a computer</b>	
Flowchart . . . . .	153
Using the provided OLYMPUS Master software . . . . .	154
What is OLYMPUS Master? . . . . .	154
Installing OLYMPUS Master . . . . .	155
Connecting the camera to a computer . . . . .	159
Starting OLYMPUS Master . . . . .	161
Displaying the camera's images on your computer . . . . .	162
Downloading images to save on your computer . . . . .	162
Disconnecting the camera from your computer . . . . .	163
Viewing still images . . . . .	164
Printing images . . . . .	165
Transferring images to your computer without using OLYMPUS Master . . . . .	166
<b>11 Appendix</b>	
If you encounter problems . . . . .	168
Error codes . . . . .	168
Troubleshooting . . . . .	169
Camera maintenance . . . . .	174
Cleaning and storing the camera . . . . .	174
Cleaning mode — Removing dust on the CCD . . . . .	175
Pixel mapping — Checking the image processing functions . . . . .	176
Glossary . . . . .	177
<b>12 Information</b>	
Menu directory . . . . .	183
Available functions by shooting mode . . . . .	187
Names of parts . . . . .	190
Camera . . . . .	190
Viewfinder indications . . . . .	192
Monitor indications (only for playback) . . . . .	193
Control panel screen . . . . .	194
Information . . . . .	196
Specifications . . . . .	196

### 13 Accessories

---

BLM-1 Li-ion Battery / BCM-2 Li-ion Battery Charger .....	199
How to use the LBH-1 Lithium Battery Holder .....	206
ZUIKO DIGITAL interchangeable lenses .....	208
ZUIKO DIGITAL 14-45mm f3.5-5.6 .....	210
ZUIKO DIGITAL 17.5-45mm f3.5-5.6 .....	212
Index .....	214

## For customers in North and South America

### For customers in USA

Declaration of Conformity

Model Number : E-500

Trade Name : OLYMPUS

Responsible Party : OLYMPUS IMAGING AMERICA INC.

Address : Two Corporate Center Drive, P.O. Box 9058, Melville, NY  
11747-9058 U.S.A.

Telephone Number : 1-631-844-5000

Tested To Comply With FCC Standards

FOR HOME OR OFFICE USE

This device complies with Part 15 of the FCC rules. Operation is subject to the following two conditions:

- (1) This device may not cause harmful interference.
- (2) This device must accept any interference received, including interference that may cause undesired operation.

### For customers in Canada

This Class B digital apparatus meets all requirements of the Canadian Interference-Causing Equipment Regulations.

## For customers in Europe



"CE" mark indicates that this product complies with the European requirements for safety, health, environment and customer protection. "CE" mark cameras are intended for sales in Europe.



This symbol [crossed-out wheeled bin WEEE Annex IV] indicates separate collection of waste electrical and electronic equipment in the EU countries.

Please do not throw the equipment into the domestic refuse.

Please use the return and collection systems available in your country for the disposal of this product.

This product and bundled accessories conform to WEEE standards.

## Trademarks

- IBM is a registered trademark of International Business Machines Corporation.
- Microsoft and Windows are registered trademarks of Microsoft Corporation.
- Macintosh is a trademark of Apple Computer, Inc.
- xD-Picture Card™ is a trademark.
- All other company and product names are registered trademarks and/or trademarks of their respective owners.
- The standards for camera file systems referred to in this manual are the "Design Rule for Camera File System/DCF" standards stipulated by the Japan Electronics and Information Technology Industries Association (JEITA).

## Safety precautions



### CAUTION

RISK OF ELECTRICAL SHOCK  
DO NOT OPEN



**CAUTION:** TO REDUCE THE RISK OF ELECTRICAL SHOCK, DO NOT REMOVE COVER (OR BACK). NO USER-SERVICEABLE PARTS INSIDE. REFER SERVICING TO QUALIFIED OLYMPUS SERVICE PERSONNEL.



Lightning flash with an arrowhead, enclosed in a triangle, alerts you to the presence of uninsulated voltage points inside the product which could cause a serious electrical shock.



An exclamation mark enclosed in a triangle alerts you to important operating and maintenance instructions in the documentation provided with the product.

### WARNING!

TO AVOID THE RISK OF FIRE OR ELECTRICAL SHOCK, NEVER EXPOSE THIS PRODUCT TO WATER OR OPERATE IN A HIGH HUMIDITY ENVIRONMENT.

## General Precautions

**Read All Instructions** — Before you use the product, read all operating instructions.

**Save These Instructions** — Save all safety and operating instructions for future reference.

**Heed Warnings** — Read carefully and follow all warning labels on the product and those described in the instructions.

**Follow Instructions** — Follow all instructions provided with this product.

**Cleaning** — Use only a damp cloth for cleaning. Never use any type of liquid or aerosol cleaner, or any type of organic solvent to clean this product.

**Attachments** — For your safety, and to avoid damaging the product, use only accessories recommended by Olympus.

**Water and Moisture** — Never use this product around water (near a bathtub, kitchen sink, laundry tub, wet basement, swimming pool or in the rain).

**Location** — To avoid damage to the product and prevent personal injury, never place this product on an unstable stand, tripod, bracket, table or cart. Mount only on a stable tripod, stand, or bracket. Follow the instructions that describe how to safely mount the product, and use only the mounting devices recommended by the manufacturer.

**Power Sources** — Connect this product only to the power source described on the product label. If you are not sure about the type of power supply in your home, consult your local power company. Refer to your operating instructions for information on using the product with a battery.

**Foreign Objects, Liquid Spillage** — To avoid personal injury caused by fire or electrical shock from contact with internal high voltage points, never insert a metal object into the product. Avoid using the product where there is a danger of spillage.

**Heat** — Never use or store this product near any heat source such as a radiator, heat register, stove, or any type of equipment or appliance that generates heat, including stereo amplifiers.

**Servicing** — Refer all servicing to qualified personnel. Attempting to remove the covers or disassemble the product, could expose you to dangerous high voltage points.



**Damage Requiring Service** — If you notice any of the conditions described below, refer servicing to qualified service personnel:

- Liquid has been spilled onto the product or some other object has fallen into the product.
- The product has been exposed to water.
- The product does not operate normally despite following operating instructions. Adjust only the controls described in the operating instructions as improper adjustment of other controls could damage the product and require extensive repair work by a qualified technician.
- The product has been dropped or damaged in any way.
- The product exhibits a distinct change in performance.

**Replacement Parts** — When replacement parts are required, make sure that the service center uses only parts with the same characteristics as the originals, as recommended by the manufacturer. Unauthorized substitution of parts could result in fire, electrical shock, or create other hazards.

**Safety Check** — Upon completion of servicing or repairs, ask the service technician to perform safety checks to determine that the product is in good working order.

## Handling the Camera

 <b>DANGER</b>	If the product is used without observing the information given under this symbol, serious injury or death may result.
 <b>WARNING</b>	If the product is used without observing the information given under this symbol, injury or death may result.
 <b>CAUTION</b>	If the product is used without observing the information given under this symbol, minor personal injury, damage to the equipment, or the loss of valuable data may result.

### **WARNING**

- **Do not use the camera in areas exposed to flammable or explosive gases.**  
A fire or explosion may result.
- **Do not use the flash on people (infants, small children, etc.) at close range.**  
When you fire the flash, you must be at least 1 m (3 ft) away from the faces of your subjects. Firing the flash too close to the subject's eyes could cause a momentary loss of vision.

- **Keep young children and infants away from the camera.**

If not, the following dangerous situations may occur:

- Becoming entangled in the camera strap or power cords, causing strangulation. If this happens, follow the doctor's instructions.
- Accidentally swallowing the battery or other small parts.
- Accidentally firing the flash into their own eyes or those of another child.
- Accidentally being injured by the moving parts of the camera.

- **Do not use or store the camera in dusty or humid places.**

Using or storing the camera in dusty or humid places may result in a fire or electric shock.

- **Do not cover the flash with a hand while firing.**

Do not cover the flash or touch it after it has just been fired sequentially. It may be hot and cause minor burns.

- **Do not take apart or modify the camera.**

Never attempt to disassemble the camera. The internal circuits contain high voltage points which could cause serious burns or electrical shock.

- **Do not let water or foreign objects inside the camera.**

A fire or electric shock may result. If the camera is accidentally dropped in water, or if liquid is spilled into the camera, stop using it, allow it to dry, and then remove the battery. Contact the nearest authorized Olympus service center.

- **Do not touch the battery or the battery charger while battery charging is in progress.**

Wait until charging is complete and the battery has cooled.

The battery and battery charger become hot while charging. At these times, they may cause minor burns.

- **Do not use a non-specified battery and/or charger.**

Use of a non-designated battery and/or re-charger may lead to camera or battery failure as well as other unexpected accidents. Any accidents resulting from use of non-designated equipment will not be compensated.

## **CAUTION**

- **Stop using the camera immediately if you notice any unusual odors, noise, or smoke around it.**

If you notice any unusual odors, noise, or smoke around the camera during operation, switch it off immediately — and remove the battery. Allow the camera to sit idle for a few minutes to cool. Take the camera outdoors, away from flammable objects, and carefully remove the battery. Never remove the battery with bare hands. Contact the nearest Olympus service center immediately.

- **Do not use the camera with wet hands.**

Damage or electric shock may result. Also, do not connect or disconnect the power plug with wet hands.

- **Be careful with the strap when you carry the camera.**

It could easily catch on stray objects — and cause serious damage.

- **Do not leave the camera in areas subject to extremely high temperature.**

Doing so may cause parts to deteriorate and, in some circumstances, cause the camera to catch fire.



- **When the camera contains metal parts, overheating can result in a low-temperature burn. Pay attention to the following:**
  - When used for a long period, the camera will get hot. If you hold on to the camera in this state, a low-temperature burn may be caused.
  - In places subject to extremely cold temperatures, the temperature of the camera's body may be lower than the environmental temperature. If possible, wear gloves when handling the camera in cold temperatures.
- **Do not damage the power cable.**

Do not pull on the charger's cable or add another cable to it. Be sure to connect or disconnect the charger's cable while holding the power plug. If the following cases occur, stop using and contact an Olympus dealer or authorized customer support center.

  - The power plug or cable produces heat, burning smell, or smoke.
  - The power plug or cable is cracked or broken. The contact is bad on the power plug.

## Battery handling precautions

---

Follow these important guidelines to prevent the battery from leaking, overheating, burning, exploding, or causing electrical shocks or burns.

### **DANGER**

---

- **Never heat or incinerate the battery.**
- **Do not connect the (+) and (-) terminals to each other using metal objects.**
- **Do not carry or store the battery where it may come into contact with metal objects such as jewelry, pins, fasteners, etc.**
- **Never store the battery where it will be exposed to direct sunlight, or subjected to high temperatures in a hot vehicle, near a heat source, etc.**
- **Never attempt to disassemble the battery or modify it in any way, such as by soldering.**

Doing so may break the terminals or cause battery fluid to splash, resulting in potential fire, explosion, battery leakage, overheating or other damage.
- **If battery fluid gets in your eyes, loss of eyesight may result.**

If battery fluid gets in your eyes, do not rub them. Flush them immediately with clear, cold running water and seek medical attention straight away.

### **WARNING**

---

- **Keep the battery dry at all times. Never allow it to come into contact with fresh or salt water.**
- **Do not touch or hold the battery with wet hands.**
- **If the rechargeable battery does not recharge within the specified time, stop charging it and do not use it.**

If you do not, fire, explosion, ignition or overheating may result.
- **Do not use the battery if it is cracked or broken.**

Doing so may cause explosion or overheating.
- **Never subject the battery to strong shocks or continuous vibration.**

Doing so may cause explosion or overheating.

- **Never attempt to modify the battery compartment on the camera, never insert anything (other than the specified battery) into the compartment.**
- **If the battery leaks, becomes discolored or deformed, or appears abnormal in any way during operation, stop using the camera immediately.**  
Contact your dealer or an authorized Olympus service center. Continued use may result in fire or electric shock.
- **If the battery leaks fluid onto your clothing or skin, remove the clothing and flush the affected area with clean, running cold water immediately. If the fluid burns your skin, seek medical attention immediately.**

### **CAUTION**

- **Do not remove the battery from the camera immediately after operating the camera on battery power for a long time.**  
Doing so may cause burns.
- **Remove the battery from the camera if it is not going to be used for a long time.**  
Otherwise, battery leakage or overheating may cause a fire or injury.

## Handling and storage precautions

### Camera

- To protect the high-precision technology contained in this product, never leave the camera in the places listed below, no matter if in use or storage:
  - Places where temperatures and/or humidity are high or go through extreme changes. Direct sunlight, beaches, locked cars, or near other heat sources (stove, radiator, etc.) or humidifiers.
  - In sandy or dusty environments.
  - Near flammable items or explosives.
  - In wet places, such as bathrooms or in the rain.
  - In places subject to strong vibrations.
- Never drop the camera or subject it to severe shocks or vibrations.
- Do not leave the camera pointed directly at the sun. This may cause lens damage, color failure, ghosting on the CCD, or may possibly start a fire.
- Condensation may form inside the camera when there is a sudden extreme change in temperature (such as when moving from indoors to outdoors). Acclimatize the camera to the temperature (e.g. by putting the camera into a plastic bag) before use.
- If the camera has not been used for a long time, mold may form or the camera may malfunction. Before using the camera, check that the camera works properly.
- Do not touch electric contacts on cameras and interchangeable lenses. Remember to attach the cap when removing the lens.

- Do not place the camera near anything that could be affected by magnetism (e.g. credit card, floppy disk, etc.). Doing so may destroy the data on these items.

### **LCD monitor**

---

- Do not push the monitor forcibly; otherwise the image may become fuzzy, resulting in a playback mode failure or damage to the monitor. If the monitor is damaged, be careful not to get any of the liquid crystals from the monitor in your mouth. If liquid crystals get on your limbs or clothes, wash them off.
- A strip of light may appear on the top/bottom of the monitor. This is not a malfunction.
- When a subject is viewed diagonally in the camera, the edges may appear to zigzag on the monitor. This is not a malfunction; it will be less noticeable in playback mode.
- In places subject to low temperatures, the LCD monitor may take a long time to turn on or its color may change temporarily. When using the camera in extremely cold places, it is a good idea to occasionally place it in a warm place. A LCD monitor exhibiting poor performance due to low temperatures will recover in normal temperatures.
- The LCD monitor is made with high-precision technology. However, black spots or bright spots of light may appear on the LCD monitor. These spots may not be uniform in color and brightness depending on their characteristics or the angle at which you are viewing the monitor. This is not a malfunction.

### **FCC Notice**

---

#### **● Radio and Television Interference**

Change or modifications not expressly approved by the manufacturer may void the user's authority to operate this equipment. This equipment has been tested and found to comply with the limits for a Class B digital device, pursuant to Part 15 of the FCC Rules. These limits are designed to provide reasonable protection against harmful interference in a residential installation.

This equipment generates, uses, and can radiate radio frequency energy and, if not installed and used in accordance with the instructions, may cause harmful interference to radio communications.

However, there is no guarantee that interference will not occur in a particular installation. If this equipment does cause harmful interference to radio or television reception, which can be determined by turning the equipment off and on, the user is encouraged to try to correct the interference by one or more of the following measures:

- Adjust or relocate the receiving antenna.
  - Increase the distance between the camera and receiver.
  - Connect the equipment to an outlet on a circuit different from that to which the receiver is connected.
  - Consult your dealer or an experienced radio/TV technician for help.
- Only the OLYMPUS-supplied USB cables should be used to connect the camera to USB-enabled personal computers (PC).

Any unauthorized changes or modifications to this equipment would void the user's authority to operate.

## **Legal and other notices**

---

- Olympus makes no representations or warranties regarding any damages, or benefit expected by using this unit lawfully, or any request from a third person, which are caused by the inappropriate use of this product.
- Olympus makes no representations or warranties regarding any damages or any benefit expected by using this unit lawfully which are caused by erasing picture data.

## **Disclaimer of Warranty**

---

- Olympus makes no representations or warranties, either expressed or implied, by or concerning any content of these written materials or software, and in no event shall be liable for any implied warranty of merchantability or fitness for any particular purpose or for any consequential, incidental or indirect damages (including but not limited to damages for loss of business profits, business interruption and loss of business information) arising from the use or inability to use these written materials or software or equipment. Some countries do not allow the exclusion or limitation of liability for consequential or incidental damages, so the above limitations may not apply to you.
- Olympus reserves all rights to this manual.

## **Warning**

---

- Unauthorized photographing or use of copyrighted material may violate applicable copyright laws. Olympus assumes no responsibility for unauthorized photographing, use or other acts that infringe upon the rights of copyright owners.

# 1

## Basic operations

This camera is equipped with a variety of easy shooting modes that automatically adjust focus and exposure as required, as well as automatically popping up the built-in flash when required.

A variety of advanced shooting modes are available, enabling you to take advantage of professional shooting techniques. Many functions can be set or adjusted with easy button operations while referring to the menus displayed on the large-size LCD monitor.

Now, let's take a closer look at how to use the functions and menus.

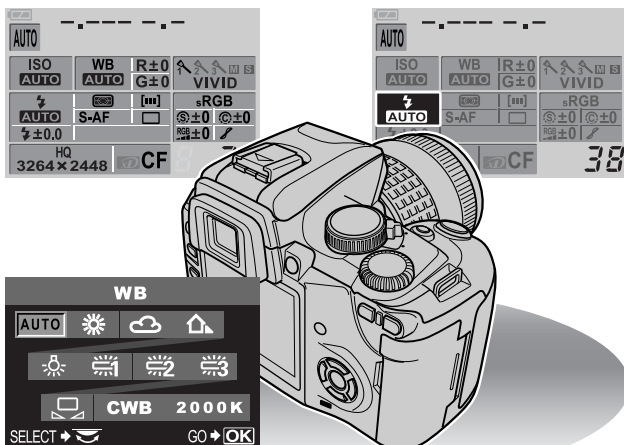

## How to use the mode dial

This camera has the following shooting modes, which can be switched using the mode dial.

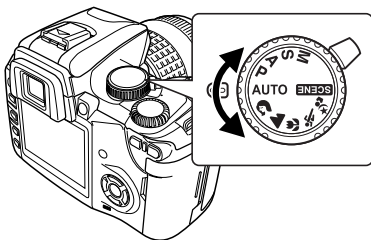

1

Basic operations

### Easy shooting modes

This camera features 6 creative modes and 15 scene modes that automatically optimize the exposure for the subject.

#### **AUTO** Full-auto shooting

Allows you to shoot using a lens aperture (f value) and shutter speed set by the camera. In low-light conditions, the flash automatically pops up and fires. This mode is recommended for normal shooting conditions.

#### **Portrait shooting**

Suitable for shooting a portrait-style image of a person.  P. 34

#### **Landscape shooting**

Suitable for shooting landscapes and other outdoor scenes.  P. 34

#### **Macro shooting**

Suitable for taking close-up pictures (macro shooting).  P. 34

#### **Sport shooting**

Suitable for capturing fast-moving action without blurring.  P. 34

#### **Night scene and portrait shooting**

Suitable for shooting both the main subject and background at night.  P. 34

#### **SCENE** Scene mode

15 different scene modes are available to suit a wide range of shooting situations. When the mode dial is set to this mode, the scene menu is displayed.  P. 35

## Advanced shooting modes

The 4 shooting modes below will help you take advantage of a variety of advanced shooting techniques.

### **P** Program shooting

Allows you to shoot using an aperture and shutter speed that the camera sets.

 P. 39

### **A** Aperture priority shooting

Allows you to set the aperture manually. The camera sets the shutter speed automatically.

 P. 41

### **S** Shutter priority shooting

Allows you to set the shutter speed manually. The camera sets the aperture automatically.

 P. 43

### **M** Manual shooting





Allows you to set the aperture and shutter speed manually.

 P. 45

### **Automatic flash pop-up**

When you use any of the shooting modes listed below in a low-light environment, the flash will automatically pop up.

• **AUTO**   

• Any of the following scene modes:     

## Control panel screen display

1 When the power switch is set to ON, the control panel screen (shooting information) is displayed on the monitor.

- If the control panel screen does not appear, press the **INFO** button.
- When the mode dial is set to **SCENE**, the scene menu is displayed.  P. 35

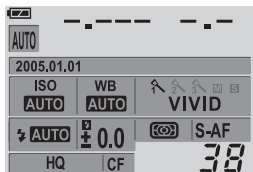
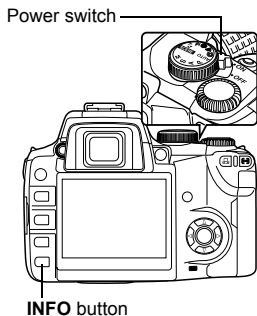

Normal

2 Each time the INFO button is pressed, the display changes as follows:

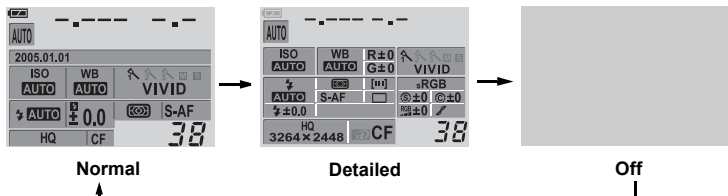

## How to make function settings

This camera features a wide variety of shooting functions designed to suit a variety of different shooting conditions. You can also customize settings to make the camera easier for you to use.

There are three basic ways to make function settings with this camera.

- ① Setting using direct buttons
- ② Setting on the control panel screen
- ③ Setting on the menu

By mastering these operating methods, you'll be able to make good use of the camera's versatile functions. Available functions differ depending on the shooting mode.



## Setting using direct buttons

### 1 Press the button for the function you want to set (direct button).

- The direct menu is displayed.

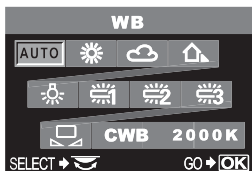

Ex.) When setting white balance



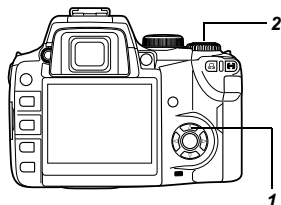



Direct menu



### 2 Use the control dial to set.

- If you do not operate the control dial within a few seconds ("Button timer"  P. 136), the control panel screen will be restored and your setting will be confirmed. Your setting can also be confirmed by pressing the  button.

### List of direct buttons

	Direct buttons	Function	Ref. Page
①	<b>WB</b> (White balance) button	Sets white balance	P. 85
②	<b>AF</b> (Focus mode) button	Sets focus mode	P. 70
③	<b>ISO</b> button	Sets ISO sensitivity	P. 82
④	 (AF frame selection) button	Selects AF frame	P. 69
⑤	 (Metering) button	Sets metering mode	P. 77
⑥	 (Remote control / Selftimer/Drive) button	Sets Remote control / Selftimer / Drive	P. 62, P. 63 P. 65
⑦	 (Exposure compensation) button	Sets exposure compensation value	P. 79
⑧	 (Flash) switch	Sets flash mode	P. 53

## Setting on the control panel screen

# 1

## Basic operations

### 1 Press the **OK** button.

- The cursor on the control panel screen lights.

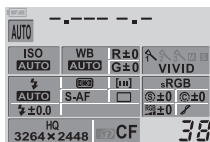

Control panel screen

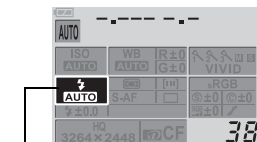

Cursor

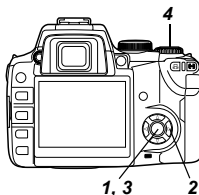

### 2 Use the arrow pad **⬅️** to move the cursor to the function you want to set.

Ex.) When setting white balance

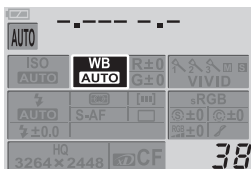

### 3 Press the **OK** button.

- The direct menu is displayed.

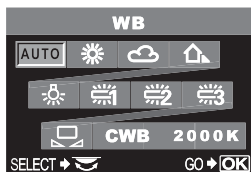

Direct menu

### 4 Use the control dial **⌚** to set.

- You can also use the control dial to make settings on the control panel screen display after completing step 2.
- If you do not operate the control dial within a few seconds ("Button timer" P. 136), the control panel screen will be restored and your setting will be confirmed. Your setting can also be confirmed by pressing the **OK** button.

#### Control panel operation procedures

This manual shows the control panel operation procedures (until the direct menu is displayed) as below.

Ex.) When setting white balance

**OK** ▶ **⬅️** **WB** ▶ **OK**

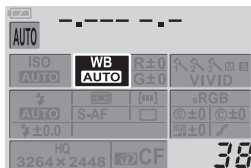

## Setting on the menu

### 1 Press the **MENU** button.

- The menu is displayed on the monitor.

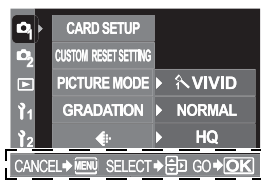

MENU button

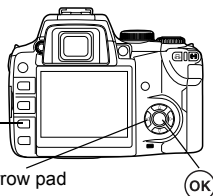

Operation guide is displayed at the bottom of the screen.

**CANCEL** → : Press **MENU** to cancel the setting.

**SELECT** → : Press to select the item.  
The illustration displayed corresponds to the arrow pad shown below.



**GO** → **OK** : Press **OK** to confirm your settings.

### 2 Use to select a tab.

- The functions are categorized under tabs.

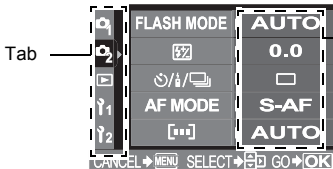

The current setting is displayed.



Moves to the functions under the tab you have selected.

#### Types of tabs

- Sets shooting functions.
- Sets shooting functions.
- Sets playback functions.
- Customizes shooting functions.
- Sets functions that allow you to use the camera efficiently.

## 3 Select a function.

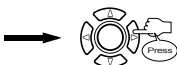
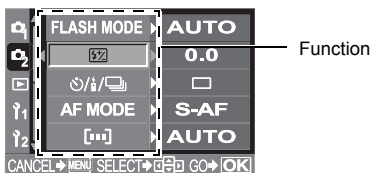

Goes to the selected function's setting screen. (Some functions can be set on the menu.)

## 4 Select a setting.

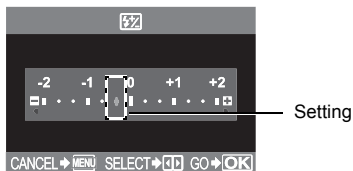

Setting screen

5 Press **OK** repeatedly until the menu disappears.

- Normal shooting screen is restored.

**Menu operation procedures**

This manual shows the menu operation procedures as below.

**Ex.) When setting white balance**

**Menu** ▶ [**WB**] ▶ [WB] ▶ **Setting**

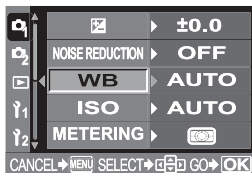

For the menu lists, refer to the menu directory (P. 183).

## 2

# Things to know before shooting

The camera focuses automatically if you simply press the shutter button in the **AUTO** mode. However, sometimes you may come across a subject that is difficult to focus on. This chapter explains how to deal with those hard-to-focus subjects. Another important thing is to select the appropriate record mode before you start shooting. Remember that depending on what you are going to do with your shots later, you may find that the image looks grainy in large prints, the file size is too big for e-mail, etc. To avoid this kind of problem, always check the record mode before shooting.

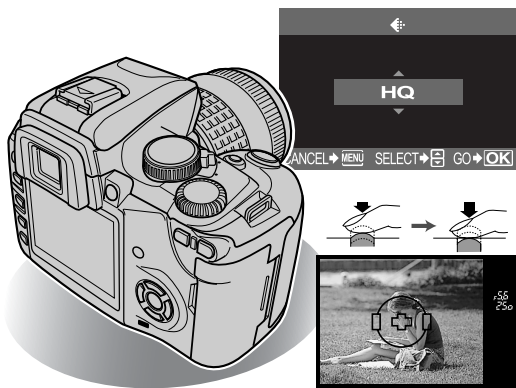

## How to use card media

The camera is equipped with two card slots; you can use CompactFlash or Microdrive simultaneously with the xD-Picture Card.

### Selecting the card type

Select the type of card you want to use (xD-Picture Card or CompactFlash).

1 Menu ▸ [ ]2 ▸ [CF/xD]

2 Use  to set.

[CF] CompactFlash

[xD] xD-Picture Card

3 Press the  button.

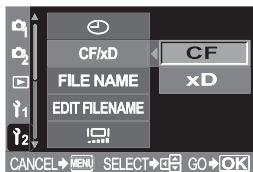



### Formatting the card

Formatting prepares cards to receive data. Non-Olympus cards or cards formatted on a computer must be formatted with the camera before they can be used.

All data stored on the card, including protected images, is erased when the card is formatted. When formatting a used card, confirm there are no images that you still want to keep on the card.

1 Menu ▸ [ ]1 ▸ [CARD SETUP]

2 Use  to select [FORMAT]. Press the  button.

3 Press   to select [YES]. Press the  button.

- Formatting is performed.



2

Things to know before shooting

## If correct focus cannot be obtained

The camera's auto-focus may not be able to focus on the subject in the cases shown below (e.g. when the subject is not in the center of the frame, when the subject has lower contrast than its surroundings, etc.). If this happens, the easiest solution is to use focus lock.

### Subjects that are difficult to focus on

The AF confirmation mark blinks.  
The subject cannot be brought into focus.

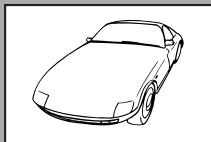

Subject with low contrast

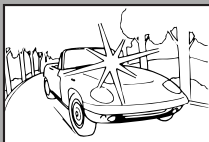

Excessively bright light  
in center of frame

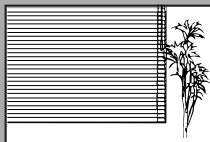

Subject with repeated  
patterns

The AF mark stays lit, but the subject cannot be brought into focus.



Subjects at different  
distances

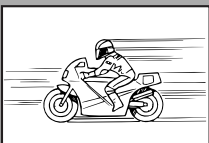

Fast-moving subject



Subject not inside AF frame

## How to use focus lock (if the subject is not positioned in the center of the frame)

- 1 Position the AF frame on the subject you want to focus on.

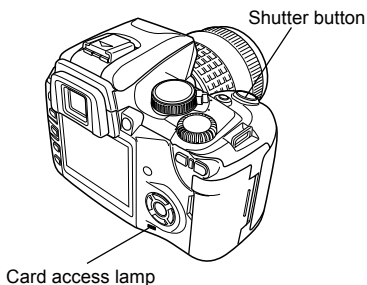
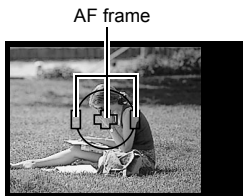

2

Things to know before shooting

**2 Press the shutter button halfway until the AF confirmation mark lights.**

- The focus is locked. The AF confirmation mark and the AF focusing frame light up in the viewfinder.
- If the AF confirmation mark blinks, press the shutter button halfway again.
- The control panel screen disappears.

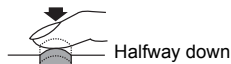

AF confirmation mark

**3 While keeping the shutter button pressed halfway, re-compose your shot.**



**4 Press the shutter button all the way.**

- The card access lamp blinks while the picture is being stored on the card.

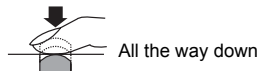

**If the subject has lower contrast than its surroundings**

Focus (focus lock) on a high-contrast object the same distance away as the intended subject, re-compose your shot and then take the picture. If the subject has no vertical lines, hold the camera vertically and adjust the focus using the focus lock function, then return the camera to the horizontal position to take the picture.



## Selecting the record mode

You can select a record mode in which to take pictures. Choose the record mode that's best for your purpose (printing, editing on a PC, website editing, etc.). For details about record modes and number of pixels, refer to the table on P. 31.

### Types of record modes

Record mode allows you to select a combination of pixel count and compression rate for the images you record. An image consists of pixels (dots). When you enlarge an image with a low pixel count, it will be displayed as a mosaic. If an image has a high pixel count, the file size (amount of data) will be larger and the number of storable still pictures will be lower. The higher the compression, the smaller the file size. However, the image will have less clarity when played back.

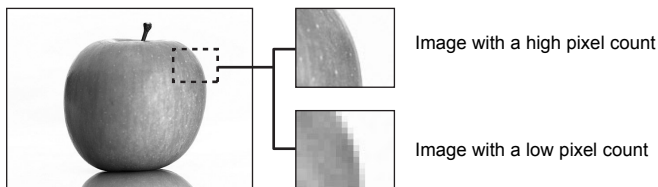

**← Image becomes clearer**

Application	Number of pixels	Quality (Compression)				
		Non-compression 1/1	Low compression 1/2.7	High compression 1/4	High compression 1/8	High compression 1/12
Select for the print size	3264x2448	TIFF	SHQ	HQ		
	3200x2400 2560x1920 1600x1200 1280x960 1024x768	—	SQ			
For small-sized print and website	640x480					

Number of pixels increases ↑

## How to select the record mode

- 1 Menu ▶ [ ] ▶ [ ]
- 2 Use to set.  
[RAW] / [TIFF] / [SHQ] / [HQ] / [SQ] /  
[RAW+SHQ] / [RAW+HQ] / [RAW+SQ]
- 3 Press the button.



## Setting the number of pixels and compression rate

- 1 Menu ▶ [ ] ▶ [HQ]  
Menu ▶ [ ] ▶ [SQ]
- 2 Follow the steps depending on the record mode you have selected.

### [HQ]

- 1) Use to set the compression rate.  
[1/4] / [1/8] / [1/12]

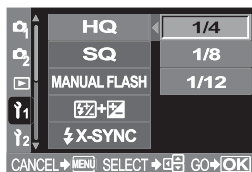

### [SQ]

- 1) Use to set the number of pixels.  
[3200x2400] / [2560x1920] / [1600x1200] /  
[1280x960] / [1024x768] / [640x480]
  - 2) Use to set the compression rate.  
[1/2.7] / [1/4] / [1/8] / [1/12]
- 3 Press the button.

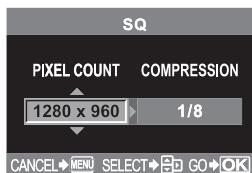

**Record mode**

Record mode	Number of pixels (PIXEL COUNT)	Compression	File format	File size (MB)
RAW	3264x2448	Uncompressed	ORF	13.6
TIFF		Uncompressed	TIFF	24.5
SHQ		1/2.7	JPEG	6.4
HQ		1/4		4.5
		1/8		2.5
		1/12		1.8
	SQ	3200x2400		1/2.7
1/4				4.4
1/8				2.4
1/12				1.8
2560x1920		1/2.7		3.7
		1/4		2.5
		1/8	1.3	
		1/12	0.8	
1600x1200		1/2.7	1.5	
		1/4	1.0	
		1/8	0.5	
		1/12	0.4	
1280x960	1/2.7	0.9		
	1/4	0.6		
	1/8	0.3		
	1/12	0.2		
1024x768	1/2.7	0.6		
	1/4	0.4		
	1/8	0.2		
	1/12	0.2		
640x480	1/2.7	0.3		
	1/4	0.2		
	1/8	0.1		
	1/12	0.1		

The file size in the table is approximate.

**Notes**

- The number of remaining pictures may change according to the subject or factors like whether print reservations have been made or not. In certain instances, the number of remaining pictures displayed on the viewfinder or the monitor does not change even when you take pictures or stored images are erased.
- The actual file size varies depending on the subject.

# 3

## Selecting the right mode for shooting conditions

Close-ups of small objects like flowers or jewelry, capturing a fast-moving subject like a child running around, shooting with a natural-looking illuminated background at night — did you ever wonder how to achieve the results you want without complicated and time-consuming camera settings?

With this camera, you will find a new way of capturing all those special moments and effects in an instant. All you have to do is to select the appropriate scene mode from the “Easy shooting modes” and concentrate on your composition; no complicated settings as with other cameras.

You can also set the aperture value and shutter speed in the “Advanced shooting modes”. The more you shoot, the more possibilities you will discover.



## Shooting modes

This camera has different shooting modes, which can be switched using the mode dial.

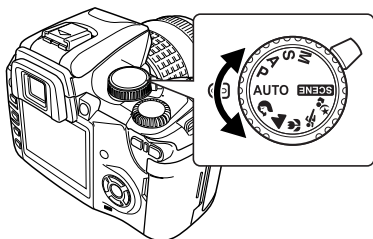

Easy shooting modes ..... **AUTO**, , , , , , , **SCENE**  
Advanced shooting modes ..... **P, A, S, M**

**AUTO** is recommended for normal shooting conditions.

The shutter speed and aperture value that have been set automatically by the camera are displayed on the viewfinder and control panel screen. When the camera is set to **SCENE**, the scene menu is displayed.

Control panel screen

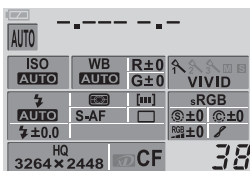

Viewfinder



### **Shutter speed indication**

If the selected shutter speed is less than 1 second, only its denominator will be displayed such as 250 for 1/250 sec., and if more than 1 second, a double-quote mark " will be displayed such as 2" for 2 sec.

# Easy shooting modes

When you select a mode to suit the shooting situation, the camera optimizes the settings for the shooting situations.

## Creative modes

- 1 Set the mode dial to the mode you want to use.



**AUTO** Full-auto shooting  
The camera sets the optimum aperture value and shutter speed automatically according to the subject brightness. In low-light conditions, the flash automatically pops up and fires. **AUTO** is recommended for normal shooting conditions.



Portrait



Landscape



Macro



Sport



Night scene + Portrait

**SCENE** 15 different scene modes are available. "Scene modes" (P. 35)

- 2 Press the shutter button halfway.

- Focusing is performed and the AF confirmation mark lights on the viewfinder.
- The shutter speed and aperture value that have been set automatically by the camera are displayed on the viewfinder.

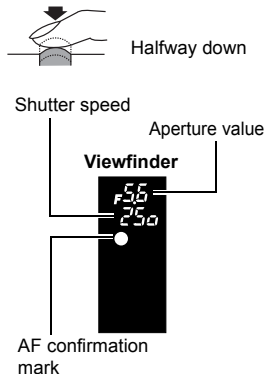



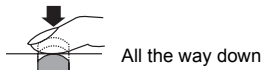

- 3 Press the shutter button all the way.

- The image is recorded on the card.



## Scene modes

- 1 Set the mode dial to **SCENE**.
  - The scene menu appears.
- 2 Use   to select the scene mode.
  - A sample image of the selected mode is displayed.
- 3 Press the  button.
  - The camera enters the shooting stand-by mode.
  - To change the setting, press the  button again. The scene menu appears.



### 1 PORTRAIT



Suitable for shooting a portrait-style image of a person. Only the subject is brought into focus with a blurred background.



### 2 LANDSCAPE

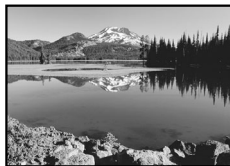

Suitable for shooting landscapes and other outdoor scenes. Vivid reproduction of blues and greens.



### 3 LANDSCAPE+PORTRAIT



Suitable for shooting both main subject and background. The camera brings both of them into focus.



## 4 NIGHT SCENE



Suitable for shooting images of outdoor scenes in the evening or at night.

Usually a street at night makes a dark image with only the sparkle of lights such as street lamps due to the lack of brightness. This mode allows you to capture the true appearance of the street.

- Since the shutter speed is slow, be sure to stabilize the camera.



## 5 NIGHT+PORTRAIT



Suitable for shooting both the main subject and background at night.

Since the shutter speed is slow, be sure to stabilize the camera.

- The flash fires in the red-eye reduction mode.  
     "Flash shooting" (P. 50)



## 6 CHILDREN



Since AF is performed continuously, you can take pictures of children at play without blurring.



## 7 SPORT



Suitable for capturing fast-moving action without blurring.



**HI** 8 HIGH KEY

Optimized for bright scenes. Subject brightness is correctly reproduced, producing an image with impact.

**LOW** 9 LOW KEY

Optimized for dark scenes. Subject darkness is correctly reproduced, without producing dark shadows.

**🌻** 10 MACRO

The camera closes the aperture and focuses across a wider range in the forward and backward directions (more depth of field) to enable you to shoot close-up pictures (macro shooting).

- If you use the flash, shadows may be noticeable and the correct exposure may not be achieved.

**🕯** 11 CANDLE

Suitable for shooting under candlelight. Warm colors are reproduced.

- The flash cannot be used.



## 12 SUNSET



Suitable for taking sunset pictures.  
Vivid red and yellow color reproduction.

- The flash cannot be used.
- Since the shutter speed is slow, be sure to stabilize the camera.



## 13 FIREWORKS



Suitable for shooting fireworks.

- Since the shutter speed is slow, be sure to stabilize the camera.
- The flash cannot be used.
- AF is not possible. Use manual focus (MF).



## 14 DOCUMENTS

### Motion JPEG Image & Sound Recording\*

With the provided 8MB SmartMedia, Motion JPEG image & sound recording up to 15 seconds in HQ mode (320x240 pixels) or 62 seconds in SQ mode (160x120 pixels) is possible.

\*Sound is recorded in Wave format.

### Built-In Microphone

With the built-in microphone, you can record up to 4 seconds of sound per still image.

### Picture Effects

Black & White, Sepia, White Board, or Black Board can be selected giving you greater control over image style. With White Board and Black Board modes, pictures of letters can be taken extra-clearly.

Suitable for shooting documents, etc. Increases contrast between letters and background.

- The flash cannot be used.



## 15 BEACH & SNOW



Suitable for shooting snow-capped mountain landscapes, white sand beaches, seascapes, etc.

## Advanced shooting modes

For more advanced shooting and greater creative control, you can set the aperture value and shutter speed.

### P : Program shooting

The camera sets the optimum aperture value and shutter speed automatically according to the subject brightness. This mode is useful if you do not necessarily want to use the flash.

You can also perform program shift as needed to change the combination of aperture and shutter speed while keeping the correct EV (exposure value).

#### 1 Set the mode dial to P.



#### 2 Press the shutter button halfway.

- Focusing is performed and the AF confirmation mark lights on the viewfinder.
- The shutter speed and aperture value that have been set automatically by the camera are displayed on the viewfinder.

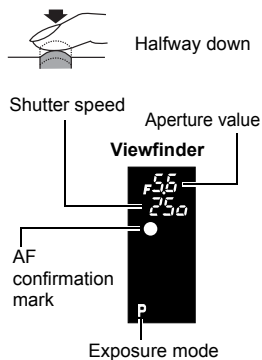
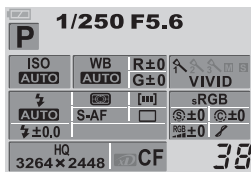

#### 3 Press the shutter button all the way.

- The image is recorded on the card.

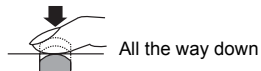

3

Selecting the right mode for shooting conditions

## Aperture values and shutter speeds in the *P* mode

In the **P** mode, the camera is programmed so that the aperture value and shutter speed are selected automatically according to the subject brightness as shown below.

— When using the  
ED 50mm f2  
MACRO lens

(e.g. when EV is 7, the  
aperture value is set to F2  
and the shutter speed to  
1/30.)

— When using the  
14mm-54mm  
f2.8-3.5 zoom  
lens (focal  
length : 54mm)

• • • • When using the  
14mm-54mm  
f2.8-3.5 zoom  
lens (focal  
length : 14mm)

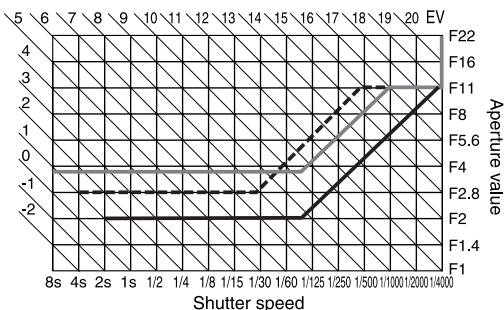

## Program shift (*Ps*)

By rotating the control dial in the **P** mode, you can change the combination of aperture and shutter speed while keeping the optimum exposure.

The program shift setting will not be canceled after shooting. To cancel program shift setting, rotate the control dial so that the viewfinder indication **Ps** changes to **P** or turn off the power. Program shift is not available when you are using a flash.

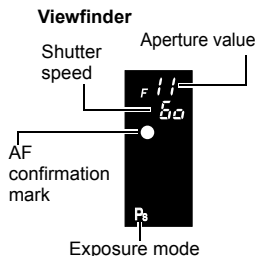

## A : Aperture priority shooting

The camera sets the optimum shutter speed automatically for the aperture value you have selected. When you open the aperture (decrease the aperture value), the camera will focus within a shorter range (shallow depth of field) and produce a picture with a blurred background. Conversely, when you close the aperture (increase the aperture value), the camera will focus over a wider range in the forward and backward directions (more depth of field), producing a picture with clear focus throughout the image area. Before shooting, you can use the preview function to check how the background will look in your picture.



When the aperture value (f-number) is decreased



When the aperture value (f-number) is increased

**1** Set the mode dial to **A**.



**2** Rotate the control dial  to set the aperture value.

Large aperture (f-number is decreased)

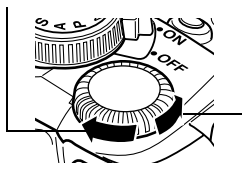

Small aperture (f-number is increased)

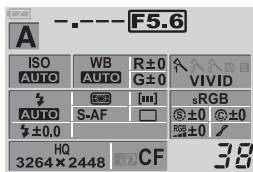

### 3 Press the shutter button halfway.

- Focusing is performed and the AF confirmation mark lights on the viewfinder.
- The shutter speed that has been set automatically by the camera is displayed on the viewfinder.

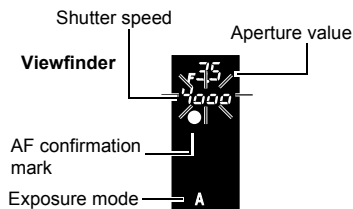
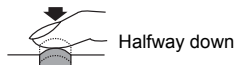

Overexposed when the shutter speed indication is blinking. Increase the aperture value (f-number).

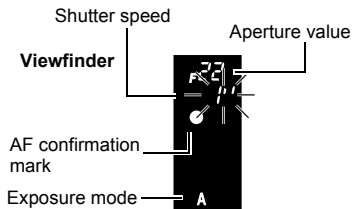

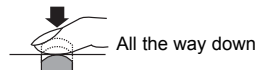

Underexposed when the shutter speed indication is blinking. Decrease the aperture value (f-number).

### 4 Press the shutter button all the way.



#### TIPS

**The shutter speed indication does not stop blinking after the aperture value is changed.**

- If the shutter speed indication is blinking when set to a high speed, set the ISO sensitivity to a lower value or use a commercially-available ND filter (for adjusting the amount of light).  "ISO — Setting the desired sensitivity to light" (P. 82)
- If the shutter speed indication is blinking when set to a lower speed, set the ISO sensitivity to a higher value.  "ISO — Setting the desired sensitivity to light" (P. 82)

**To change the EV step interval:**

- In the menu, set the EV step interval to 1/3EV, 1/2EV or 1EV.  "EV step" (P. 123)

**To check the depth of field with the selected aperture value:**

- Refer to "Preview function" (P. 47)

## S : Shutter priority shooting

The camera sets the optimum aperture value automatically for the shutter speed you have selected. Set the shutter speed depending on the type of effect you want: a higher speed shutter allows you to capture a fast-moving subject without blur, and a slower shutter speed blurs a moving subject, creating a feeling of speed or motion.



A fast shutter speed can freeze a fast action scene without any blur.



A slow shutter speed blurs a moving subject, generating a sense of movement to create a more powerful visual impact.

### 1 Set the mode dial to **S**.

### 2 Rotate the control dial to set the shutter speed.

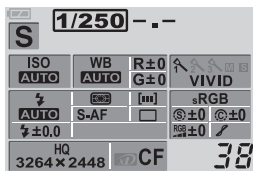

Slower shutter speed

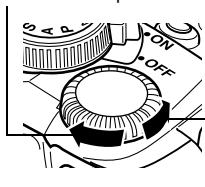

Faster shutter speed

### 3 Press the shutter button halfway.

- Focusing is performed and the AF confirmation mark lights on the viewfinder.
- The aperture value that has been set automatically by the camera is displayed on the viewfinder.

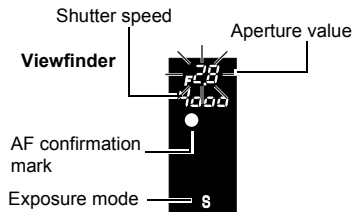
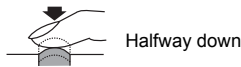

If the aperture value indication at the minimum value is blinking\*, the correct exposure has not been attained (underexposed). Set the shutter speed slower.

\* The aperture value at the moment when its indication blinks varies depending on the lens type and focal length of the lens.

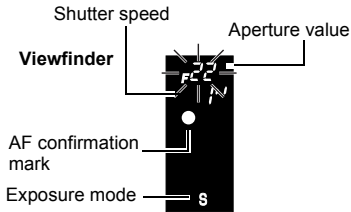

If the aperture value indication at the maximum value is blinking\*, the correct exposure has not been attained (overexposed). Set the shutter speed higher.

### 4 Press the shutter button all the way.

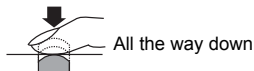



#### TIPS

#### The picture looks blurred.

→ The possibility of camera shake spoiling your picture increases greatly during macro or ultra-telephoto shooting. Set the shutter speed higher or use a monopod or tripod to stabilize the camera.

#### The aperture value indication does not stop blinking after the shutter speed is changed.

→ If the aperture value indication at the maximum value is blinking, set the ISO sensitivity to a lower value or use a commercially-available ND filter (for adjusting the amount of light).  "ISO — Setting the desired sensitivity to light" (P. 82)

→ If the aperture value indication at the minimum value is blinking, set the ISO sensitivity to a higher value.  "ISO — Setting the desired sensitivity to light" (P. 82)

#### To change the EV step interval:

→ In the menu, set the EV step interval to 1/3EV, 1/2EV or 1EV.  "EV step" (P. 123)



## M : Manual shooting

You can set both aperture value and shutter speed manually, while referring to the exposure level indicator. This mode gives you more creative control, allowing you to make whatever settings you like, regardless of the correct exposure. Bulb shooting is also possible, allowing you to take astronomical or fireworks pictures.

- 1 Set the mode dial to **M**.
- 2 Rotate the control dial  to set the value.

- **Control dial factory default settings:**

To set the shutter speed: Rotate the control dial.

To set the aperture value: Rotate the control dial while holding down the  (exposure compensation) button.

Setting [DIAL] changes the control dial function so that aperture value can be set by simply rotating the control dial.

- The range of aperture values available depends on the lens type.
- The shutter speed can be set to 1/4000 - 60"(sec.) or [bulb].
- The aperture value and shutter speed change in 1/3 EV increments as the dial is rotated.

Large aperture (f-number is decreased)

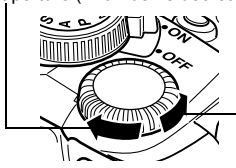

Small aperture value (f-number is increased)

Slower shutter speed

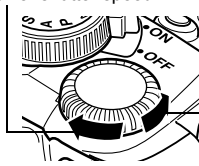

Faster shutter speed

- The exposure level indicator appears on the control panel screen, showing the difference (ranging from -3 EV to +3 EV) between the exposure value calculated by the currently selected aperture and shutter speed compared to the exposure value considered optimum by the camera.

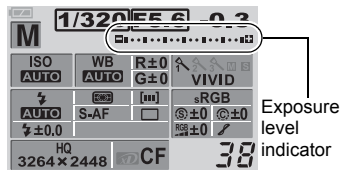
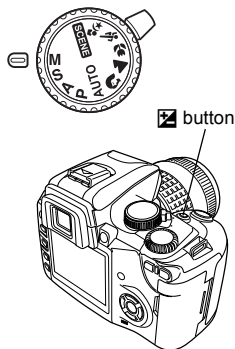

If the difference between the currently set exposure and the optimum exposure is outside the range of available indicator levels, “◀” or “▶” will blink on the left or right end of the exposure level indicator.

 Underexposure

 Overexposure

 Optimum exposure

### 3 Take the picture.

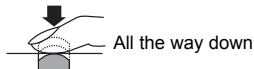

### **Noise in images**

During shooting at slow shutter speeds of 30 or more seconds, noise may appear on-screen or the image may be overly bright in the top left part of the screen. These phenomena are caused when current is generated in those sections of the CCD that are not normally exposed to light, resulting in a rise in temperature in the CCD or CCD drive circuit. This can also occur when shooting with a high ISO setting in an environment exposed to heat. The NOISE REDUCTION function helps reduce this noise.  "Noise reduction" (P. 95)

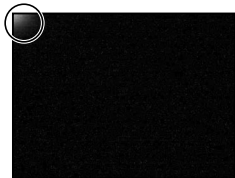

### **Bulb shooting**

You can take a picture with a bulb exposure time in which the shutter stays open as long as you hold down the shutter button (up to 8 minutes). Set the shutter speed to [bulb] in the M mode. Bulb shooting can also be done using the optional remote control (RM-1).  "Bulb shooting on the remote control" (P. 67)

### **TIPS**





#### The picture looks blurred.

→ The possibility of camera shake spoiling your picture increases greatly when you take a picture at slow shutter speed. Use a monopod or tripod to stabilize the camera.

#### To change the EV step interval:

→ In the menu, set the EV step interval to 1/3EV, 1/2EV or 1EV.  "EV step" (P. 123)

## Preview function

If you press the  (One-touch WB) button, the viewfinder shows the actual depth of field (the distance from the nearest to the furthest point of perceived "sharp" focus) in a picture, with the selected aperture value. Assign preview function to the  button beforehand.  "  button function" (P. 128)

**1** Press the  button.

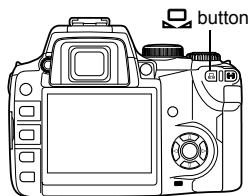

### Notes

- The metering values cannot be changed in the preview mode.

# 4

## Various shooting functions

The flash and drive modes (sequential shooting) are the keys to advanced shooting techniques. Selecting a flash mode to suit a specific shooting situation or adjusting the amount of light emitted by the flash will produce an image that is different from what would be obtained when less precise settings are used. In shooting modes such as AUTO, PORTRAIT, and NIGHT+PORTRAIT, the built-in flash will automatically pop up in low light or backlight conditions.

With Drive mode, you can take several pictures of the same scene in sequence with different exposure or white balance settings (Auto bracketing). There is no need to change the settings before taking each picture.

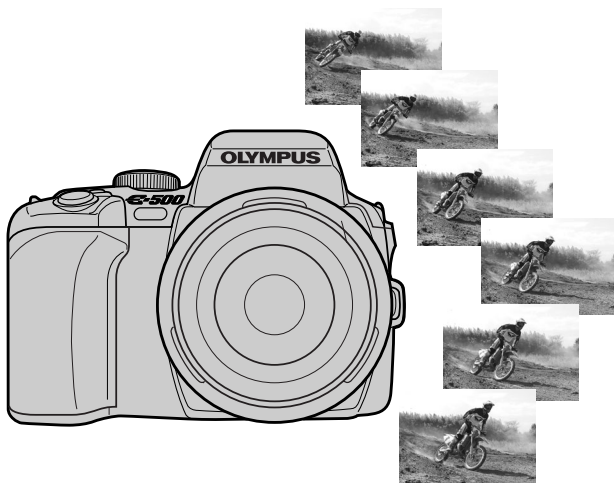

## Auto bracketing

You can shoot with compensated values such as exposure and white balance. This is useful for obtaining the optimum value.

This camera is capable of the following types of auto bracketing:

Auto bracketing	Comparison	Ref. Page
AE bracketing	Shoots multiple frames at different exposure values.	P. 83
WB bracketing*	Creates frames with different white balances from one shot.	P. 92
MF bracketing	Shoots multiple frames at different focusing points.	P. 74
Flash bracketing	Shoots multiple frames, changing the amount of light emitted by the flash for each shot.	P. 57

\* The WB bracketing function can be used at the same time as any of the other bracketing functions.

## Flash mode

The camera sets the flash mode according to various factors such as firing pattern and flash timing. Available flash modes depend on the exposure mode. The flash modes are available to optional external flashes.

When the mode dial is set to AUTO, the built-in flash will pop up automatically in low light conditions.

### Auto-flash AUTO

The flash fires automatically in low light or backlight conditions.

To shoot a subject with backlighting, position the AF frame over the subject.

### Red-eye reduction flash

In the red-eye reduction flash mode, a series of pre-flashes are emitted just before the regular flash fires. This helps accustom the subject's eyes to the bright light and minimizes the red-eye phenomenon.



The subject's eyes appear red.

### Notes

- After the pre-flashes, it takes about 1 second before the shutter is released. Hold the camera firmly to avoid camera movement.
- Effectiveness may be limited if the subject is not looking directly at pre-flashes, or if the shooting range is too far. Individual physical characteristics may also limit effectiveness.

### Slow synchronization/Red-eye reduction flash SLOW

The slow synchronization flash is designed for slow shutter speeds. Normally, when shooting with a flash, shutter speeds cannot go below a certain level to prevent camera movement. But when shooting a subject against a night scene, fast shutter speeds can make the background too dark. Slow synchronization allows you to capture both the background and the subject. Red-eye reduction is also available. Since the shutter speed is slow, be sure to stabilize the camera by using a tripod so as not to cause the picture to be blurred.

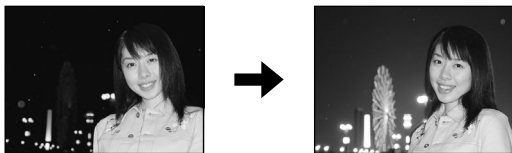

## 1st curtain

Usually, the flash fires right after the shutter fully opens. This is called 1st curtain. Unless you change it, this is how the flash always fires.

## Slow synchronization/Red-eye reduction flash ⚡ SLOW2

2nd curtain flash fires just before the shutter closes. Changing the flash timing can create interesting effects in your picture, such as expressing the movement of a car by showing the tail-lights streaming backwards. The slower the shutter speed, the better the effects turn out. The slowest possible shutter speed depends on the shooting mode.

When the shutter speed is set to 2 sec.

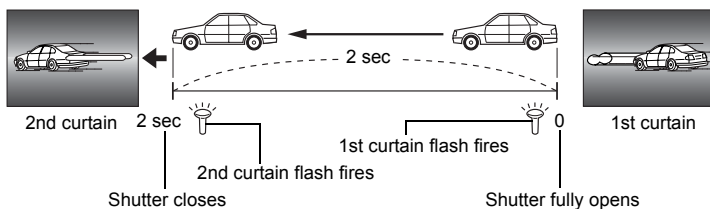

## Fill-in flash ⚡

The flash fires regardless of the light conditions. This mode is useful for eliminating shadows on the subject's face (such as shadows from tree leaves), in a backlight situation, or for correcting the color shift produced by artificial lighting (especially fluorescent light).



### Notes

- When the flash fires, the shutter speed is set to 1/180 sec. or less. When shooting a subject against a bright background with the fill-in flash, the background may be overexposed. In this case, use the optional FL-50/FL-36 external flash and shoot in the Super FP flash mode.

**Flash off** 

The flash does not fire.

In this mode, the flash can be used as an AF illuminator when it is raised.

 "AF illuminator" (P. 75)

**Flash synchronization speed**

Shutter speed can be changed when the built-in flash fires.

 "Speed synchronization" (P. 126)

**4****Manual flash**

This allows the built-in flash to output a fixed amount of light. With [MANUAL FLASH] set to [ON] ( P. 125), the amount of light can be selected in the flash mode setting.

To shoot with manual flash, set the f value on the lens based on the distance to the subject.

Ratio of amount of light	GN: Guide number	
	Built-in flash	F-36 external flash (optional)
FULL (1/1)	13	36
1/4	6	18
1/16	3	9
1/64	1.5	4.5

Calculate the f value on the lens using the following formula.

























$$\text{Aperture (f value)} = \frac{\text{GN} \times \text{ISO sensitivity}}{\text{Distance to the subject (m)}}$$

**ISO sensitivity**

ISO value	100	200	400	800	1600
Correction coefficient	1.0	1.4	2.0	2.8	4.0



**Flash modes available in different exposure mode**

Exposure mode	Control panel screen/menu display	Flash mode	Conditions to timing	Conditions to fire the flash	Shutter speed restrictions	
P A      	AUTO	Auto-flash	1st curtain	Fires automatically in dark/backlit *1 conditions	1/30 sec. - 1/180 sec.	
		Auto-flash (red-eye reduction)				
		Fill-in flash				Always fires
		Flash off	-	-	-	
	 SLOW	Slow synchronization (red-eye reduction)	1st curtain	Fires automatically in dark/backlit *1 conditions	60 sec. - 1/180 sec.	
	 SLOW	Slow synchronization (1st curtain)				
	 SLOW2	Slow synchronization (2nd curtain)	2nd curtain			
	 FULL	Manual flash (FULL)	1st curtain			
	 1/4	Manual flash (1/4)				
	 1/16	Manual flash (1/16)				
 1/64	Manual flash (1/64)					
	Fill-in flash	Always fires				
 	Fill-in flash (red-eye reduction)	-	-			-
	Flash off	-	-			-
S M	 SLOW2	Fill-in flash/ Slow synchronization/ (2nd curtain)	2nd curtain	Always fires	60 sec. - 1/180 sec.	
	 FULL	Manual flash (FULL)	1st curtain			
	 1/4	Manual flash (1/4)				
	 1/16	Manual flash (1/16)				
	 1/64	Manual flash (1/64)				

\*1 When the flash is set to the Super FP mode, it detects backlight before emitting light.  "Super FP flash" (P. 60)

\*2 In  mode, AUTO, ,  and  are not available.

## Setting the flash mode

1 Flash mode

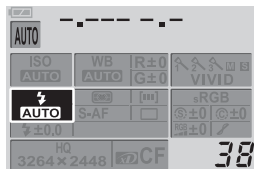

2 Use the control dial to set.

When set to **P / A** / / / / :

AUTO / / SLOW / SLOW /  
 SLOW2 / /

When set to **S / M**:

/ / SLOW2 /

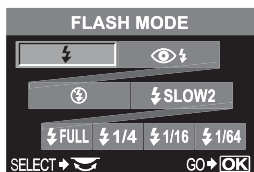

3 Press the button.

Viewfinder



: Auto-flash

: Red-eye reduction flash

: Slow synchronization (1st curtain)

: Slow synchronization (2nd curtain)

: Flash off

### Menu setting procedure

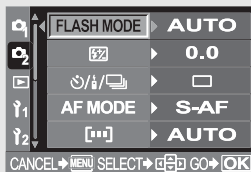









Menu [ ] [FLASH MODE] Setting

## Using the built-in flash

If you shoot a subject using a lens that is wider than 14 mm (equivalent to 28 mm on a 35 mm film camera), the light emitted by the flash may produce a vignette effect. Whether or not this occurs depends on lens type and shooting conditions (such as distance to the subject).

### 1 Set the power switch to ON. Press the ⚡ (flash) switch to raise the flash.

- When you use any of the shooting modes listed below, the built-in flash will pop up and fire automatically in low light or backlight conditions.

**AUTO** /  /  /  /  /  /  /  /  / 

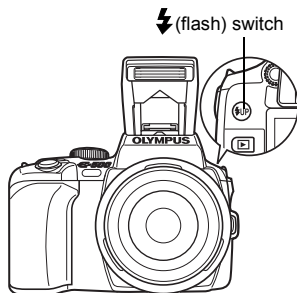

### 2 Press the shutter button halfway.

- The ⚡ (flash stand-by) mark lights when the flash is ready to fire. If the mark is blinking, the flash is charging. Wait until charging is complete.

### 3 Press the shutter button all the way.

Viewfinder

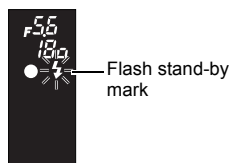

## Flash intensity control

This adjusts the amount of light emitted by the flash.

In some situations (e.g., when shooting small subjects, distant backgrounds, etc.), you may get better results by adjusting light emission. It is useful when you intend to increase the contrast (distinction between light and dark) of images to make the images more vivid.

- 1 Menu ▶ [ ] ▶ [ ]
- 2 Use to set the compensation value.
- 3 Press the button.

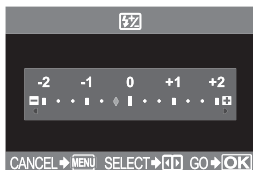

### TIPS

To call up the setting screen quickly:

- If you press the (flash) switch and the (exposure compensation) button simultaneously, the screen will appear. Use the control dial to set the value.

### Notes

- This does not work when the flash control mode on the electronic flash is set to MANUAL.
- If light emission is adjusted on the electronic flash, it will be combined with the camera's light emission setting.
- Exposure compensation is applied to flash intensity control. When [+] is set to [ON], the exposure compensation value is applied to the light emission compensation value.

## Flash bracketing

The camera shoots multiple frames, changing the amount of light emitted by the flash for each shot.

### 1 Menu ▶ [M2] ▶ [FL BKT]

### 2 Use to set.

[OFF] / [3F 0.3EV] / [3F 0.7EV] / [3F 1.0EV]

- You can change the EV step interval in the custom menu.

 "EV step" (P. 123)

### 3 Press the button.

- When the shutter button is pressed, the camera shoots 3 frames at a time in the following order; Frame with optimum amount of light emission, frame adjusted in - direction and frame adjusted in + direction.

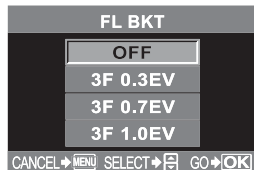

## External electronic flashes (optional)

In addition to the camera's built-in flash capabilities, you can use any of the external flash units specified for use with this camera. This enables you to take advantage of a wider variety of flash shooting techniques to suit different shooting conditions.

The external flashes communicate with the camera, allowing you to control the camera's flash modes with various available flash control modes, such as TTL, AUTO and Super FP flash. The flash can be mounted on the camera by attaching it to the camera's hot shoe. For details, refer to the external flash's manual.

### Functions available with external flash units

Optional flash	FL-50	FL-36	FL-20	RF-11	TF-22
Flash control mode	TTL AUTO, AUTO, MANUAL, FP TTL AUTO, FP MANUAL		TTL AUTO, AUTO, MANUAL	TTL AUTO, MANUAL	
GN (Guide number) (ISO100)	GN 50 (85 mm*) GN 28 (24 mm*)	GN 36 (85 mm*) GN 26 (24 mm*)	GN20 (35 mm*)	GN11	GN22

\* Calculated based on 35mm film camera.

### Notes

- The optional external flashes cannot be used with the built-in flash.
- The FL-40 optional flash cannot be used.

## Using the external electronic flash

Be sure to attach the flash to the camera before turning on the flash's power.

### 1 Remove the hot shoe cover by sliding it in the direction indicated by the arrow in the illustration.

- Keep the shoe cover in a safe place to avoid losing it, and put it back on the camera after flash shooting.

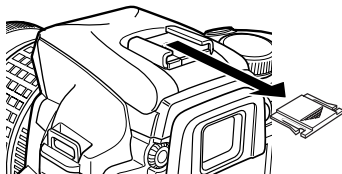

### 2 Attach the electronic flash to the hot shoe on the camera.

- If the lock pin is protruding, turn the shoe lock ring as far as it will go in the direction opposite to ◀ LOCK. This will pull the lock pin back inside.

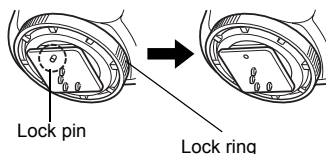

### 3 Turn on the flash.

- When the charge lamp on the flash lights up, charging is complete.
- The flash will be synchronized with the camera at a speed of 1/180 sec. or less.

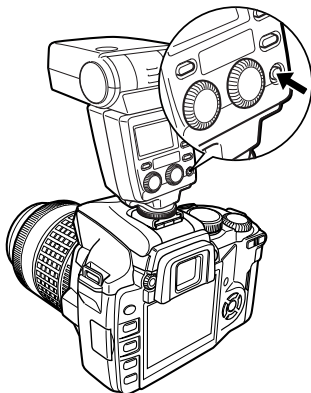

### 4 Select a flash mode.

**5 Select the flash control mode.**

- TTL-AUTO is recommended for normal use.

**6 Press the shutter button halfway.**

- Shooting information such as ISO sensitivity, aperture value, and shutter speed is communicated between the camera and flash.
- ⚡ lights up in the viewfinder.

**7 Press the shutter button all the way.****Viewfinder**

⚡ blinks:  
Flash  
charging.



⚡ lights up:  
Charging is  
complete.

**Notes**

- When shooting with the flash control mode set to TTL-AUTO, pre-flashes are emitted before firing the regular flash.
- When the flash control mode is set to TTL-AUTO, or when shooting a subject at a distance with ISO set to 400 or higher, flash control accuracy will decrease.

## Super FP flash

Super FP flash is available with the FL-50/FL-36. Super FP flash timing is longer than standard flash timing. This means that pictures can be taken at a higher shutter speed than is possible with normal flashes.

Fill-in flash shooting with the aperture open (such as in outdoor portrait shooting) is also possible with Super FP flash. For details, refer to the external flash's manual.

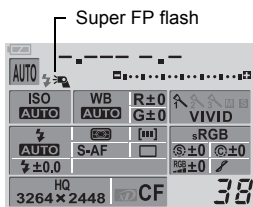

## Using commercially available flashes

Use the M exposure mode on the camera when using any commercially available flash (except optional electronic flashes specified for this camera). For details on non-specified commercial flashes, refer to P. 61.

**1 Remove the hot shoe cover to connect the flash unit to the camera.**

**2 Set the exposure mode to M mode, then set the aperture value and shutter speed.**

- Set the shutter speed to 1/180 sec. or slower. If the shutter speed is faster than this, commercially available flashes cannot be used.
- A slower shutter speed may produce blurred images.

**3 Turn on the flash.**

- Be sure to turn on the flash after attaching the flash unit to the camera.

**4 Set the ISO value and aperture value on the camera to match the flash control mode on the flash.**

- Refer to the flash's manual for instructions on how to set its flash control mode.

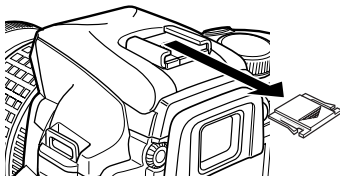



**Notes**

- The flash fires each time the shutter is released. When you do not need to use the flash, turn off the flash's power.
- Check beforehand that the flash you are using is synchronized with the camera.
- Depending on the camera's shooting mode, the built-in flash may pop up automatically and strike the external flash.
- You can prevent the flash from automatically popping up by setting the auto flash pop up function to Off.  "Auto flash popup" (P. 126)

**Non-specified commercial flashes**

Before selecting a non-specified commercial flash, be sure to read the following information carefully to determine whether or not it can be used with this camera.

- 1) Exposures when using a flash require that adjustments be made on the flash. If a flash is used in the auto mode, match it with the f value and ISO sensitivity settings on the camera.
- 2) Even if the flash auto f value and ISO sensitivity are set the same as on the camera, the correct exposure may not be obtained depending on the shooting conditions. In such a case, adjust the auto F value or ISO on the flash or calculate the distance in the manual mode.
- 3) Use a flash with an illumination angle that matches the focal length of the lens. The focal length of the lens for 35 mm film is approximately twice as long as the focal length of the lenses designed for this camera.
- 4) Do not use a flash unit or other accessory TTL flash that has additional communications functions other than the specified flashes, since it may not only fail to function normally, but may also cause damage to the camera's circuitry.



**Single-frame shooting** Shoots 1 frame at a time when the shutter button is pressed. (normal shooting mode)

**Sequential shooting** Shoots 4 frames or more at 2.5 frames/sec. (in SHQ, HQ or SQ) for as long as the shutter button pressed. Focus and exposure are locked at the first frame.

- 1 Press the (Remote control/Self-timer/Drive) button.
- 2 Use the control dial to set.
  - Single-frame shooting
  - Sequential shooting
- 3 Press the shutter button all the way to take the picture.

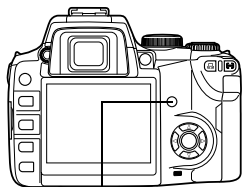

button

- Press the shutter button fully and keep it pressed. The camera will take pictures in sequence until you release the button.

#### Viewfinder



*l-d* — *l-d*: Single-frame shooting  
*b-d*: Sequential shooting

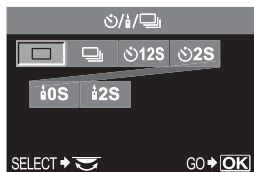

#### Control panel setting procedure



#### Menu setting procedure

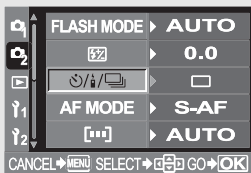

Menu [M2] Setting

### Notes

- Sequential shooting is not possible when [NOISE REDUCTION] ( P. 95) is set to [ON].
- During sequential shooting, if the battery check blinks due to low battery, the camera stops shooting and starts saving the pictures you have taken on the card. The camera may not save all of the pictures depending on how much battery power remains.



This function lets you take pictures using the self-timer. You can set the camera to trigger the shutter after either 12 or 2 seconds. Fix the camera securely on a tripod for self-timer shooting.

## Setting self-timer

**1** Press the (Remote control/Self-timer/Drive) button.

**2** Use the control dial to set.

12S 12-second self-timer

2S 2-second self-timer

Viewfinder



12SELF : 12-second self-timer

2SELF : 2-second self-timer

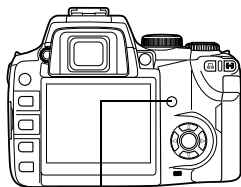

button

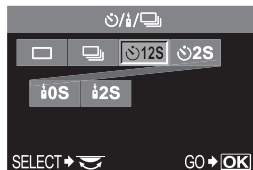

### Control panel setting procedure

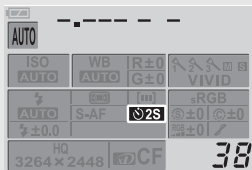

$\blacktriangleright$  Drive mode  $\blacktriangleright$

### Menu setting procedure

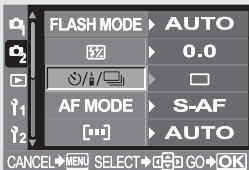

Menu  $\blacktriangleright$   $\blacktriangleright$  Setting

## Using the self-timer

### 1 Press the shutter button all the way.

- A picture is taken.
- The focus and exposure are locked when the shutter button is pressed halfway.
- **When  $\odot$ 12S is selected:** First, the self-timer lamp lights up for approximately 10 seconds, then it blinks for approximately 2 seconds and the picture is taken.
- **When  $\odot$ 2S is selected:** The self-timer lamp lights up for approximately 2 seconds, then the picture is taken.
- To cancel the activated self-timer, press the  button.

Self-timer lamp

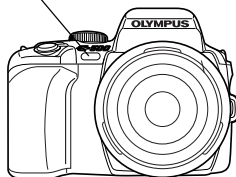

### Notes

- Do not press the shutter button while standing in front of the camera; this could result in the subject being out of focus since focusing is performed when the shutter button is pressed halfway.

### Eyepiece cover

When shooting without looking through the viewfinder, such as when using the self-timer, attach the eyepiece cover to the viewfinder so that the light does not enter the viewfinder. To attach the eyepiece cover, remove the eyecup from the camera as illustrated. To attach the optional eyecup, follow the same procedure.

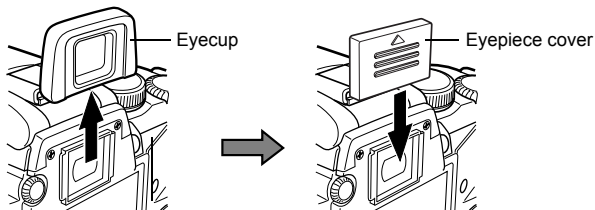



By using the optional remote control (RM-1), you can take a picture with yourself in it or a night scene without touching the camera. The camera can be set to trigger the shutter either right away or 2 seconds after the shutter button on the remote control is pressed. Bulb shooting is also possible when using the optional remote control.

## Setting the remote control

**1** Press the (Remote control/Self-timer/Drive) button.

**2** Use the control dial to set.

**0S** Triggers the shutter right away.

**2S** Triggers the shutter 2 seconds after.

Viewfinder

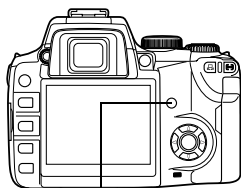
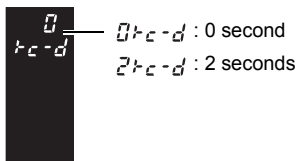

button

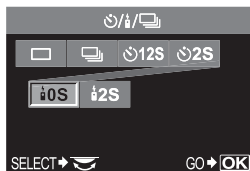

### Control panel setting procedure



### Menu setting procedure

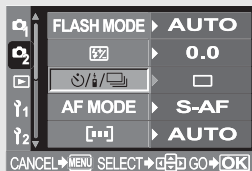

Menu  $\blacktriangleright$  [M2]  $\blacktriangleright$  [Remote control icon]  $\blacktriangleright$  Setting

## Using the remote control

- 1 Mount the camera on a tripod or place it on a stable, flat surface.
- 2 Point the remote control at the remote control receiver on the camera and press the shutter button on the remote control.

- **When  $\text{ii}0\text{S}$  is selected:**

The focus and exposure are locked, the remote control lamp blinks and the picture is taken.

- **When  $\text{ii}2\text{S}$  is selected:**

The self-timer lamp lights up for approximately 2 seconds, then the picture is taken.

Remote control lamp  
Remote control receiver

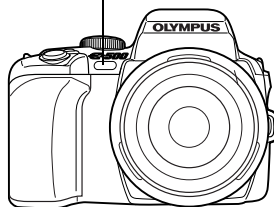

### **Transmitted signal effective area**

Point the remote control at the remote control receiver of the camera within the effective area as shown below.

Powerful lighting such as direct sunlight, fluorescent light or devices emitting electrical or radio waves could narrow the effective area.

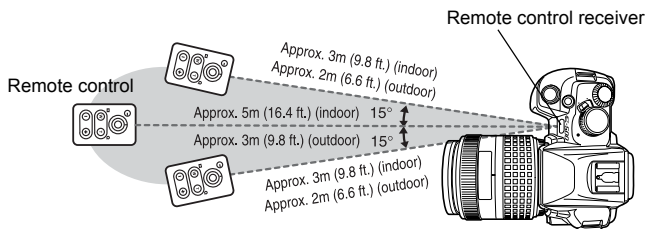

## TIPS

**The remote control lamp does not blink after the shutter button on the remote control is pressed.**

- The transmitted signal may not be effective if the remote control receiver is exposed to powerful lighting. Move the remote control closer to the camera and press the shutter button on the remote control again.
- The transmitted signal may not be effective if the remote control is too far from the camera. Move the remote control closer to the camera and press the shutter button on the remote control again.
- There is signal interference. Change the channel as described in the remote control's instruction manual.

**To cancel the remote control shooting mode:**

- The remote control shooting mode will not be canceled after shooting. Set to one of the other drive modes.

**To use the shutter button on the camera in the remote control shooting mode:**

- The shutter button on the camera still works even in the remote control shooting mode.

## Notes

- The shutter will not be released if the subject is not in focus.
- Under bright light conditions, the remote control lamp may be difficult to see, making it hard to determine whether or not the picture has been taken.
- Zoom is not available on the remote control.

## Bulb shooting on the remote control

Set the mode dial to **M**, then set the shutter speed to [bulb].

Press the W button on the remote control to open the shutter.

If 8 minutes elapse after pressing the W button, the shutter closes automatically.

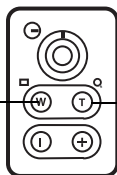

Press the T button to close the shutter.

# 5

## Focusing functions

This camera is equipped with an auto focus function that lets you focus quickly, easily, and automatically. You can also choose from a variety of other focus modes — including AF frame selection and C-AF — to suit different subjects and shooting conditions. Naturally, manual focusing is also available. Focusing is the key to great photography, so be sure to learn how to take advantage of these functions.

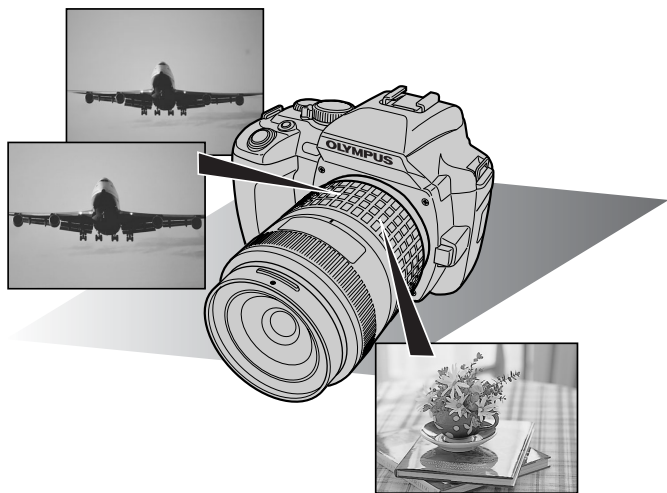



Normally, the camera measures the distance to the subject using the 3 AF frames in the viewfinder and selects the most appropriate point. This function allows you to select only one AF frame.

**[...]** (AUTO)

Focuses using the 3 AF frames.

[ ] Focuses using the left AF frame.

[•] Focuses using the center AF frame.

[ ] Focuses using the right AF frame.

Viewfinder

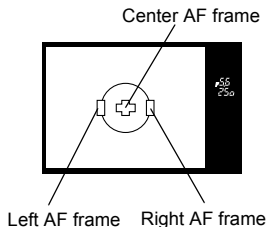

- 1 Press the [...] (AF frame selection) button.
- 2 Use the control dial to set.  
 AUTO / [ ] / [•] / [ ]
- 3 Press the shutter button all the way to take the picture.

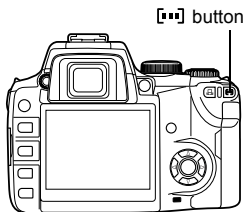

### Control panel setting procedure

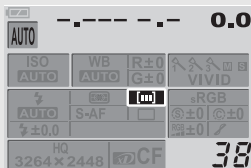

AF frame

### Menu setting procedure

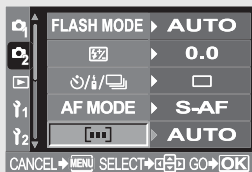

Menu ▶ [] ▶ [...] ▶ Setting

Three focus modes are available with this camera: S-AF (single AF), C-AF (continuous AF) and MF (manual focus).

**1** Press the **AF** (focus mode) button.

**2** Use the control dial  to set.

S-AF / C-AF / MF / S-AF+MF / C-AF+MF

 "S-AF (single AF) shooting" (P. 71)

"Simultaneous use of S-AF mode and MF mode (S-AF+MF)" (P. 71)

"C-AF (continuous AF) shooting" (P. 72)

"Simultaneous use of C-AF mode and MF mode (C-AF+MF)" (P. 72)

"Manual focus (MF)" (P. 73)

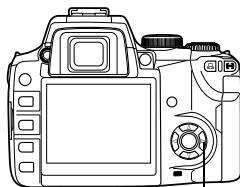

AF button

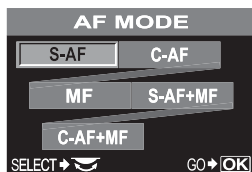

## 5

### Focusing functions

Viewfinder



S-AF : S-AF

C-AF : C-AF

-F : MF

-F S-AF : S-AF+MF

-F C-AF : C-AF+MF

Control panel setting procedure



Focus mode

Menu setting procedure

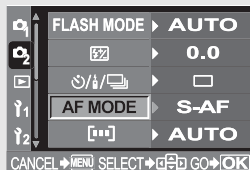

Menu [AF MODE]

## S-AF (single AF) shooting

Focusing is performed once when the shutter button is pressed halfway.

If focusing fails, release your finger from the shutter button and press it halfway again. This mode is suitable for taking pictures of non-moving subjects or subjects with limited movement.



### 1 Press the shutter button halfway.

- When the focus is locked, the AF confirmation mark lights up.
- A beep sound is output when the subject is in focus.

### 2 Press the shutter button all the way.

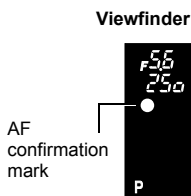

## Simultaneous use of S-AF mode and MF mode (S-AF+MF)

This function allows you to fine-adjust focus manually by turning the focus ring after AF is performed in the S-AF mode.

### 1 Press the shutter button halfway to use AF.

- When the focus is locked, the AF confirmation mark lights up.

### 2 Fine-adjust the focus using the focus ring, while keeping the shutter button pressed halfway.

### 3 Press the shutter button all the way to take the picture.

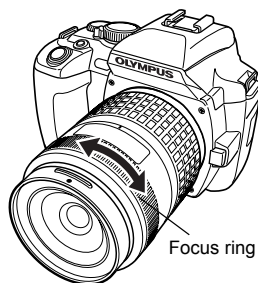

### Notes

- If the shutter button is pressed again after fine-adjusting focus with the focus ring, the AF is activated and your adjustments are canceled.

## C-AF (continuous AF) shooting

The camera repeats focusing. When the subject is in motion, the camera focuses on the subject in anticipation of its movement (Predictive AF). Even if the subject moves or you change the composition of the picture, the camera continues trying to focus.



## 5

## Focusing functions

### 1 Press the shutter button halfway and keep it in this position.

- When the subject is in focus and locked, the AF confirmation mark lights up.
- The AF frame does not light up, even when the subject is in focus.
- The camera repeats focusing. Even if the subject moves or even if you change the composition of the picture, focusing is tried continuously.
- A beep sound is output when the subject is in focus. The beep sound is not output after the second continuous AF operation, even when the subject is in focus.

Viewfinder

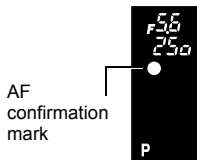

AF  
confirmation  
mark

### 2 Press the shutter button all the way.

## Simultaneous use of C-AF mode and MF mode (C-AF+MF)

This function allows you to fine-adjust focus manually by turning the focus ring after AF is performed in the C-AF mode.

- 1 Press the shutter button halfway to use AF.
- 2 Fine-adjust the focus using the focus ring.
- 3 Press the shutter button all the way to take the picture.

**TIPS****Another way to adjust focus manually using the C-AF mode:**

- Set the C-AF mode to mode 3 or mode 4 on the AEL/AFL mode setting in the custom menu.  "AEL/AFL mode" (P. 121)

**Notes**

- If the shutter button is pressed again after fine-adjusting focus with the focus ring, the AF is activated and your adjustments are canceled.

**Manual focus (MF)**

This function allows you to manually focus on any subject while looking through the viewfinder.

- 1 Adjust the focus using the focus ring.**
- 2 Press the shutter button all the way to take the picture.**

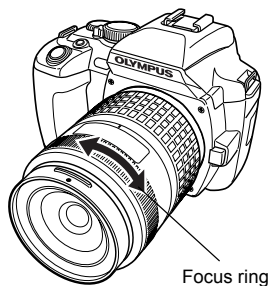
**Rotational direction of the focus ring**

You can select the rotational direction of the focus ring to suit your preference for how the lens adjusts to the focusing point.  "Focus ring" (P. 129)

**Focus aid**

When you focus the lens on a subject manually (by turning the focus ring), the AF confirmation mark lights. When 3 AF frames are selected, the camera performs focusing in the center AF frame.

## MF bracketing

The camera shoots multiple frames, changing the focal point slightly for each frame.

The frames are saved on the card in the following order: the frame with the manually set focal point, the frame with the focal point shifted backward, and the frame with the focal point shifted forward.

**1** Menu ▶ [C<sub>2</sub>] ▶ [MF BKT]

**2** Use the control dial  to set.

[OFF] / [5F 1STEP] / [5F 2STEP] /  
[7F 1STEP] / [7F 2 STEP]

**EV step** : 1STEP, 2STEP

**Number of frames**

2 frames taken with the focal point shifted forward from the one you set manually and 2 frames with the focal point shifted backward:  
Total 5 frames.

3 frames taken with the focal point shifted forward from the one you set manually and 3 frames with the focal point shifted backward:  
Total 7 frames.

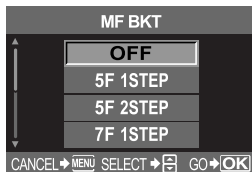

**3** Press the  button.

**4** Use MF to adjust the focus, then press the shutter button to take the picture.

- When the shutter button is pressed all the way, the camera shoots frames sequentially; the frame with the manually set focal point, the frame with the focal point shifted backward, and the frame with the focal point shifted forward.
- The number of frames with the focal point shifted back or forward from the manually set focal point may differ depending on the lens and shooting conditions.
- If the subject is not in the center of the frame or has lower contrast than its surroundings, an excessive number of frames may be shot with the focal point shifted backward or forward.
- To use MF BKT, stabilize the camera on a tripod or similar device, etc.

## AF illuminator

The built-in flash can function as an AF illuminator. This helps with focusing in low-light conditions in the AF mode.

- 1 Menu ▶ [ $\gamma_1$ ] ▶ [AF ILLUMINATOR]
- 2 Use  $\odot$  to select [ON] or [OFF].
- 3 Press the  $\odot$  button.

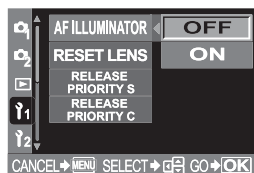

## Shutter release priority

Normally, this camera does not release the shutter while the AF is operating or the flash is charging. If you want to release the shutter without waiting until these operations have completed, use the setting below. You can set release priority in S-AF (P. 71) and C-AF (P. 72) respectively. When [RELEASE PRIORITY C] is set to [ON], Predictive AF is not available.

- 1 Follow the steps depending on the focus mode you selected.

### S-AF mode

Menu ▶ [ $\gamma_1$ ] ▶ [RELEASE PRIORITY S]

### C-AF mode

Menu ▶ [ $\gamma_1$ ] ▶ [RELEASE PRIORITY C]

- 2 Use  $\odot$  to select [ON] or [OFF].
- 3 Press the  $\odot$  button.

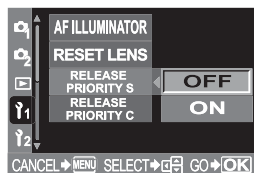

# 6

## Exposure, image and color

If you wish to go beyond simple shooting using only the shutter button, you will find various functions that can be used to modify image/brightness/exposure parameters to achieve remarkably better results. For instance, if you want to shoot atmospheric pictures indoors, or if your subject would strongly reflect the flash light, shooting without the flash would typically result in a blurred or dark picture. To overcome this problem, try adjusting the ISO setting; use a lower ISO value with normal light, and a higher ISO value with dark subjects. With exposure compensation you can adjust the image brightness and make a significant difference to how the picture turns out. Try adjusting toward minus when you want to capture images with a dark background such as green leaves in shadow or crimson foliage on a mountainside. The red, green, and yellow of autumn leaves will be beautifully reproduced, standing out against the background.

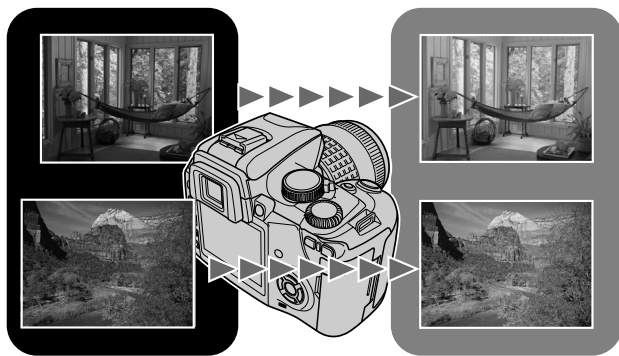



There are 5 ways to measure the subject brightness: Digital ESP metering, Center weighted averaging metering, and three types of spot metering. Select the most suitable mode for the shooting conditions.

**1** Press the  (metering) button.

**2** Use the control dial  to set.

 /  /  HI /  SH

Viewfinder



ESP  : Digital ESP metering

 : Center weighted averaging metering

 : Spot metering

HI  : Spot metering - highlight control

SH  : Spot metering - shadow control

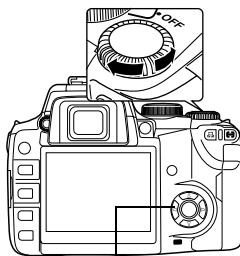

 button

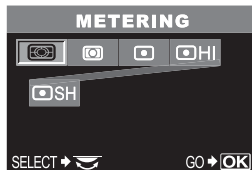

Control panel setting procedure

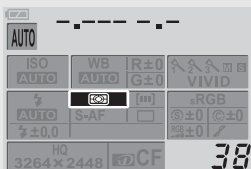

  Metering mode 

Menu setting procedure

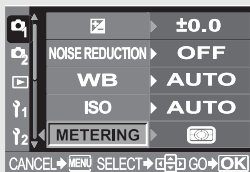

Menu    [METERING]  Setting

**📷 Digital ESP metering**

The camera measures the light levels and calculates the light level differences in 49 separate areas of the image. This precision ensures accurate metering even when there is a lot of contrast between the center of the screen and the area around it, such as when shooting backlit subjects or shooting under very bright light. This mode is recommended for general use.

**📷 Center weighted averaging metering**

This metering mode provides the average metering between the subject and the background lighting, placing more weight on the subject at the center. Use this mode when you do not want the light level of the background to affect the exposure value.

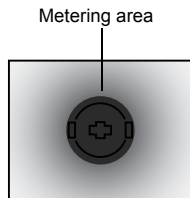
**📷 Spot metering**

The camera meters a very small area around the center of the subject, defined by the spot metering area mark in the viewfinder. Use this mode when there is very strong backlight.

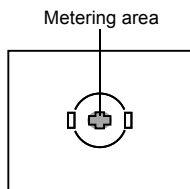
**📷 HI****Spot metering - highlight control**

When the overall background is bright, white areas of the image will come out gray if you use the camera's automatic exposure. Using this mode enables the camera to shift to over-exposure, allowing accurate white reproduction. Metering area is the same as spot metering.

**📷 SH****Spot metering - shadow control**



When the overall background is dark, black areas of the image will come out gray if you use the camera's automatic exposure. Using this mode enables the camera to shift to under-exposure, allowing accurate black reproduction. Metering area is the same as spot metering.



In some situations, you may get better results if you manually compensate (adjust) the exposure value set automatically by the camera. In many cases, bright subjects (such as snow) will turn out darker than their natural colors. Adjusting toward + makes these subjects closer to their real shades. For the same reason, adjust toward - when shooting dark subjects. The exposure can be adjusted in range of  $\pm 5.0$  EV. Center weighted averaging metering (☉) or spot metering (◼) is recommended for exposure compensation.



## 1 While holding down the (exposure compensation) button, rotate the control dial to set compensation value.

- Adjust toward +: up to +5.0 EV  
Adjust toward -: up to -5.0 EV
- The EV step interval can be selected from 1/3EV, 1/2EV or 1EV.  "EV step" (P. 123)
- You can change control dial's functionality so that exposure compensation can be set using the control dial only without pressing the  button.  "Customizing the control dial's function" (P. 127)

Adjust toward -      Adjust toward +

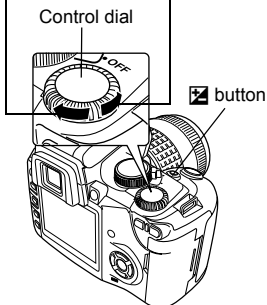

Exposure compensation indicator

### Viewfinder



Exposure compensation value

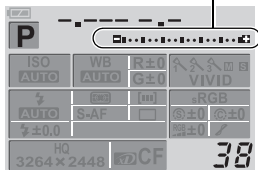

## How to read the exposure compensation indicator

### Control panel screen



Exposure compensation indicator with  
1/3EV selected



Exposure compensation indicator with  
1/2EV selected



- If the exposure compensation value exceeds the scale of the exposure compensation indicator, - or + turns red.
- The exposure compensation indicator disappears if the exposure is compensated by 0.

### Menu setting procedure

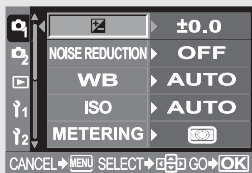

Menu ▶ [ ] ▶ [ ] ▶ Exposure compensation indicator

### Notes

- Exposure compensation is only possible in the **P**, **A** and **S** modes.

The metered exposure value can be locked with the **AEL** button (AE lock). Use AE lock when you want a different exposure setting from the one that would normally apply under the current shooting conditions.

Normally, pressing the shutter button halfway locks both AF (auto focus) and AE (automatic exposure), but you can lock the exposure alone by pressing the **AEL** button. When you lock the exposure, the metering mode (digital ESP metering, center weighted averaging metering or spot metering) selected in the menu is automatically applied. "AEL metering" (P. 123)

**1 Aim the camera toward the subject.**

**2 Hold down the AEL (AE lock) button.**

- The exposure is locked.
- **AEL** is displayed in the viewfinder.

Viewfinder

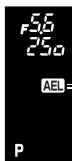

AEL button — AE lock

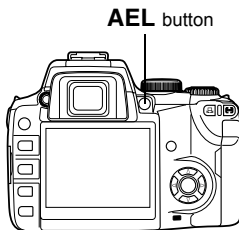

**3 Compose your shot. While holding down the AEL button, hold down the shutter button halfway.**

- The focus is locked.

**4 Press the shutter button all the way.**

- Releasing the **AEL** button cancels AE lock.
- Using the custom menu, you can set AE lock so that it is not canceled when the AEL button is released. "AEL/AF mode" (P. 121)

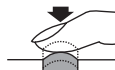

Halfway down

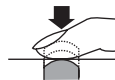

All the way down

# ISO — Setting the desired sensitivity to light

The higher the ISO value, the greater the camera's light sensitivity and the better its ability to shoot in low light conditions. However, higher values may give pictures a grainy appearance.

- 1 Press the **ISO** button.
- 2 Use the control dial  to set the ISO value.

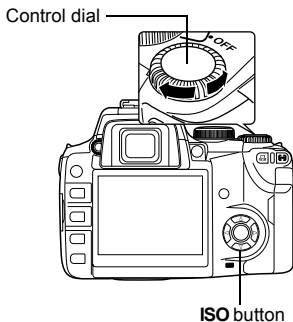
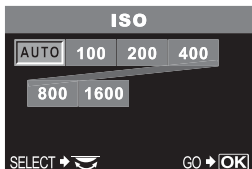

## 6

Exposure, image and color

### Control panel setting procedure



### Menu setting procedure

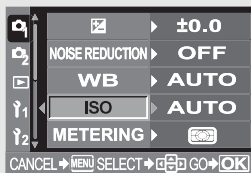

## Notes

- The ISO sensitivity when it is set to auto is usually ISO 100. If the subject is too far away for the flash illumination, the sensitivity is automatically increased.

## AE bracketing

The camera automatically shoots a number of pictures at different exposure values for each frame. Even in conditions where correct exposure is difficult to obtain (such as a backlit subject or a scene at dusk), you can pick the picture you prefer from a selected number of frames with a variety of different exposure settings (exposure and compensation values). The pictures are taken in the following order: Picture with optimum exposure, picture adjusted in - direction, and picture adjusted in + direction.

### Example:

When BKT is set to [3F 1.0EV]

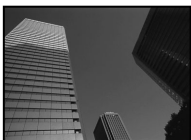

-1.0EV



±0



+1.0EV

### Compensation value: 0.3, 0.7 or 1.0

The exposure compensation values depend on the EV step interval setting that can be changed in the menu. Exposure compensation value can be adjusted within a range of ±1.0. "EV step" (P. 123)

Number of frames : 3

- 1 Menu  $\blacktriangleright$  [C2]  $\blacktriangleright$  [AE BKT]
- 2 Use the control dial to set.  
[OFF] / [3F 0.3EV] / [3F 0.7EV] / [3F 1.0EV]
- 3 Press the button.
- 4 Start shooting.

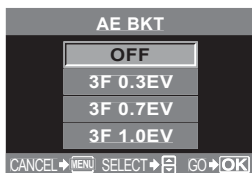

### Single-frame shooting

Each time the shutter button is pressed fully, a picture is taken at a different exposure.

- The setting for the next shot is displayed in the viewfinder.

### Sequential shooting

Hold down the shutter button until the selected number of frames are taken. The camera shoots each frame at a different exposure.

- Releasing the shutter button stops auto bracketing shooting.

### Viewfinder



EV step

**How AE bracketing compensates exposure in each exposure mode**

Depending on the selected exposure mode, exposure is compensated in the following way:

- AUTO mode** : Aperture value and shutter speed  
**P mode** : Aperture value and shutter speed  
**A mode** : Shutter speed  
**S mode** : Aperture value  
**M mode** : Shutter speed

**TIPS**

To apply AE bracketing to the exposure value you have compensated:

- Compensate the exposure value, then use the AE bracketing feature. AE bracketing is applied to the exposure value you have compensated.

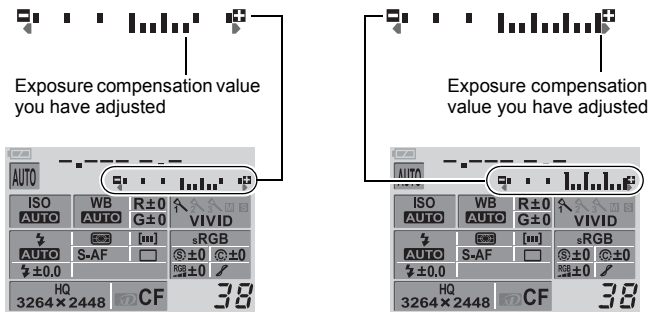
**6****Notes**

- During sequential shooting, if the battery check blinks due to low battery, the camera stops shooting and starts saving the pictures you have taken on the card. The camera may not save all of the pictures depending on how much battery power remains.



Color reproduction differs depending on the light conditions. For instance, when daylight or tungsten lighting is reflected on white paper, the shade of white produced will be slightly different for each.

With a digital camera, white color can be adjusted to reproduce more natural white with a digital processor. This mechanism is called white balance. There are 4 options for setting the WB with this camera.

### Auto white balance

This function enables the camera to automatically detect white in images and adjust the color balance accordingly.

Use this mode for any scene. If there is no near white color in the picture, the white balance of the image may not be correct. In such a case, use preset WB or one-touch WB to achieve the correct white balance.

### Preset white balance

Seven different color temperatures are programmed on this camera covering a variety of indoor and outdoor lighting including fluorescent lights and light bulbs. For example, use preset WB when you want to reproduce more red in the picture of a sunset, or capture a warmer artistic effect under artificial lighting. You can enjoy creating different color tones by trying the different preset WB settings.

### Custom white balance

You can change the color temperature of one of the preset WB settings to your liking.

 "Setting the custom white balance" (P. 89)

### One-touch white balance

You can set the optimum white balance for the shooting conditions by pointing the camera at a white object like a sheet of white paper. The white balance achieved with this setting is saved as one of the preset WB settings.

 "Setting the one-touch white balance" (P. 90)

## Color temperature

The spectral balance of different white light sources is rated numerically by color temperature — concept of physics, expressed using the Kelvin (K) temperature scale. The higher the color temperature, the richer the light in bluish tones and the poorer in reddish; the lower the color temperature, the richer the light in reddish tones and the poorer in bluish.

It follows, then, that the color temperatures of fluorescent lights make them unsuitable as artificial light sources. There are gaps in the hues from the color temperatures of fluorescent light. If these differences in hue are small, they can be calculated with color temperature and this is called correlated color temperature.

The 4000K, 4500K and 6600K preset settings in this camera are correlated color temperatures, and should not be considered strictly as color temperatures. Use these settings for shooting conditions under fluorescent lights.

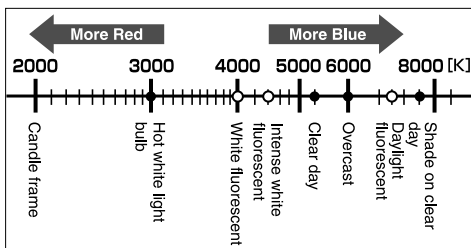

### TIPS

#### White balance with a flash:

→ Auto WB is recommended when taking pictures with the flash.

If you intend to use preset WB, select the color temperature 6000K. When shooting with the flash, be sure to play back your pictures and check the color on the screen. Various conditions affect color temperature and how color is reproduced on the screen.

### Notes

- The color temperatures for each light source indicated in the above scale are approximate. They are not an accurate indication of color. For example, the actual sunlight is not exactly 5300K, nor fluorescent lights 4000K.









## Setting the auto/preset white balance

**WB**

You can adjust the white balance by selecting the appropriate color temperature for the light conditions.

**1** Press the **WB** (white balance) button.

**2** Use the control dial  to set.

AUTO /  /  /  /  /  /  
 /  /  / CWB

Viewfinder



-R- : AUTO

-- : Preset WB

c : Custom WB

Not displayed when  
WB is set to AUTO.



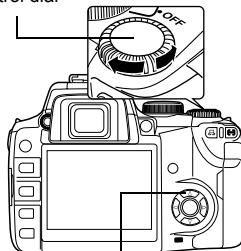



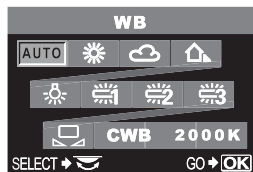

Control dial



WB button

**6**

Exposure, Image and color

WB mode	Light conditions
<b>AUTO</b>	Used for most light conditions (when there is a white portion framed in the viewfinder). Use this mode for general use.
 <b>5300K</b>	For shooting outdoors on a clear day, or to capture the reds in a sunset or the colors in a fireworks display
 <b>6000K</b>	For shooting outdoors on a cloudy day (when using the flash)
 <b>7500K</b>	For shooting outdoors in the shadows on a clear day
 <b>3000K</b>	For shooting under a tungsten light
 <b>4000K</b>	For shooting under white fluorescent lighting
 <b>4500K</b>	For shooting under a neutral white fluorescent lamp
 <b>6600K</b>	For shooting under a daylight fluorescent lamp
	Color temperature set by one-touch WB.  "Setting the one-touch white balance" (P. 90)
<b>CWB</b>	Color temperature set in custom white balance menu. When the value has not been set, it is set to 3000K. The color temperature display changes according to your CWB setting.

## Control panel setting procedure

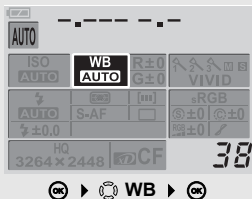

## Menu setting procedure

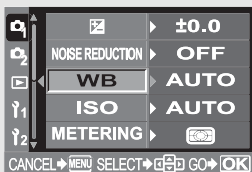

Menu ▶ [ ] ▶ [WB] ▶ Setting

### TIPS



#### When subjects with no white appear white in the image:

- In the auto WB setting, if there is no near-white color in the image framed in the screen, the white balance will not be correctly determined. In such a case, try preset WB or one-touch WB settings.

6

Exposure, image and color

## Setting the custom white balance

- 1 Press the **WB** (white balance) button.
- 2 Use the control dial  to select the custom white balance.
- 3 While holding down the  (exposure compensation) button, rotate the control dial  until the desired setting is displayed.
  - The custom white balance can be set from 2000K to 14000K.

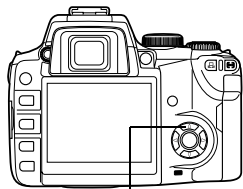

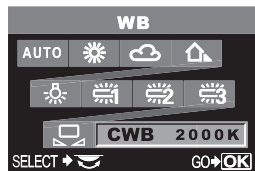

WB button

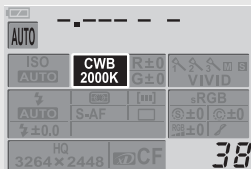

### Control panel setting procedure



  CWB  

### Menu setting procedure

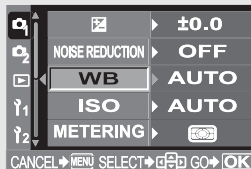

Menu    [WB]  CWB

## 6

### Exposure, image and color

## Setting the one-touch white balance

This function is useful when you need a more precise white balance than preset WB can provide. Point the camera at a sheet of white paper under the light source you want to use to determine the white balance. The optimum white balance for the current shooting conditions can be saved in the camera. This is useful when shooting a subject under natural light, as well as under various light sources with different color temperatures.

### 1 Point the camera at a sheet of white paper.

- Position the paper so that it fills the viewfinder. Make sure there are no shadows.

### 2 While holding down the , press the shutter button.

- The  screen appears.

### 3 Press the button.

- The white balance is registered.
- The registered white balance will be stored in the camera as a preset WB setting. Turning the power off does not erase the data.

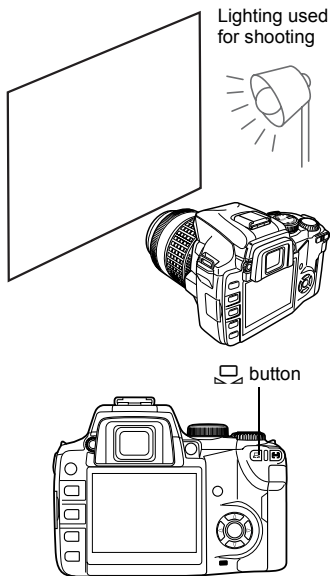

### TIPS

After pressing the shutter button, **[WB NG RETRY]** is displayed.

- When there is not enough white in the image, or when the image is too bright, too dark or the colors look unnatural, you cannot register the white balance.

Change the aperture and shutter speed settings, then repeat the procedure from Step 1.

## WB Compensation

This function lets you make fine changes to the auto WB and preset WB settings.

- 1 Menu ▸ [M] ▸ [WB]
- 2 Use  to select the white balance to adjust.

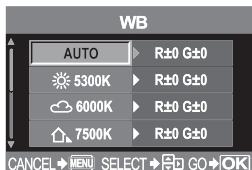



- 3 Use  to select the color direction.



**R-B** Red - Blue  
**G-M** Green - Magenta

- You can set both color directions.

### Adjusting the white balance in the R-B direction

Depending on the original WB conditions, the image will become redder each time you press , and bluer each time you press .

### Adjusting the white balance in the G-M direction

Depending on the original WB conditions, the image will become greener each time you press , and purpler each time you press .

- The white balance can be adjusted in 7 increments in each direction (R, B, G and M).

- 4 Press the  button.

- Your adjustment is saved.

## TIPS

### Checking the white balance you have adjusted:

- After performing step 3, point the camera at the subject to take test shots. When the **AEL** button is pressed, sample images that have been taken with the current WB settings are displayed.

### Adjusting all WB mode settings at once:

- "Compensating all WB" (P. 125)

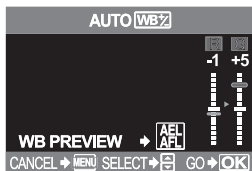

## WB bracketing

Three images with different white balances (adjusted in specified color directions) are automatically created from one shot. One image has the specified white balance, while the other two are the same image adjusted in different color directions. All three images are saved on the card.

**1** Menu ▸ [C<sub>2</sub>] ▸ [WB BKT]

**2** Use  to select the color direction.

**R-B** Red - Blue  
**G-M** Green - Magenta

- You can set both color directions.

**3** Use  to set compensation values.

[OFF] / [3F 2STEP] / [3F 4STEP] /  
 [3F 6STEP]

**4** Take the picture.

- When the shutter button is pressed down all the way, images adjusted in specified color directions are automatically created.

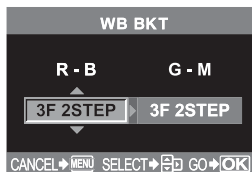

## 6

### TIPS

To apply WB bracketing to white balance you have adjusted:

- Adjust white balance manually, then use the WB bracketing feature. WB bracketing is applied to your white balance adjustment.

### Notes

- During WB bracketing, the camera cannot shoot in sequence if there is not enough memory in the camera and card for storing more than the selected number of frames.



## Picture mode

You can select image tone to create unique image effects. You can also fine-adjust image parameters such as contrast and sharpness for each mode.

### 1 Menu ▶ [P1] ▶ [PICTURE MODE]

### 2 Use to select the picture effect mode.

- [VIVID] Produces vivid colors.
- [NATURAL] Produces natural colors.
- [MUTED] Produces flat tone.
- [MONOTONE] Produces black and white tone.
- [SEPIA] Produces sepia tone.

### 3 Use to adjust the item below.

Available adjustment parameters vary depending on the selected mode.

When selecting [VIVID] / [NATURAL] / [MUTED]

- [CONTRAST] Distinction between light and dark.
- [SHARPNESS] Sharpness of the image.
- [SATURATION] Color depth of images.

When selecting [SEPIA] / [MONOTONE]

- [CONTRAST] Distinction between light and dark.
- [SHARPNESS] Sharpness of the image.
- [B&W FILTER] Creates a black and white image. The filter color is brightened and the complementary color is darkened.

[N: NEUTRAL] Creates a normal black and white image.

[Ye: YELLOW] Reproduces clearly defined white cloud with natural blue sky.

[Or: ORANGE] Slightly emphasizes colors in blue skies and sunsets.

[R: RED] Strongly emphasizes colors in blue skies and brightness of crimson foliage.

[G: GREEN] Strongly emphasizes colors in red lips and green leaves.

[PICT. TONE] Colors the black and white image.

[N: NEUTRAL] Creates a normal black and white image.

[S: SEPIA] Sepia

[B: BLUE] Blue

[P: PURPLE] Purple

[G: GREEN] Green

### 4 Press the button.

- Your adjustment is saved.

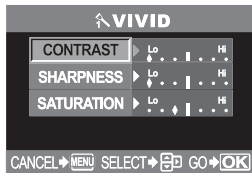
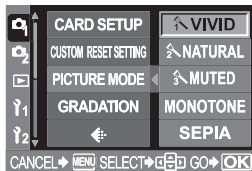

## Gradation

Two types of gradation are available.

**HIGH KEY:** Extended bright gradations.

**LOW KEY:** Extended dark gradations.



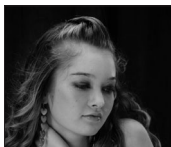

**HIGH KEY**

Suitable for a subject that is mostly highlighted.



**LOW KEY**

Suitable for a subject that is mostly shadowed.

- 1 Menu ▶ [**1**] ▶ [GRADATION]
- 2 Use  to set.  
[HIGH KEY] / [NORMAL] / [LOW KEY]
  - Use [NORMAL] mode for general uses.
- 3 Press the  button.

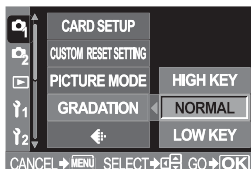



### Notes

- Contrast adjustment does not work when set to HIGH KEY or LOW KEY.

## Shading compensation

In some cases, the edges of the image may be shadowed due to the properties of the lens. The shading compensation function compensates by increasing brightness at the dark edge of the image. This function is especially useful when a wide-angle lens is used.

- 1 Menu ▶ [**2**] ▶ [SHADING COMP.]
- 2 Use  to select [OFF] or [ON].
- 3 Press the  button.

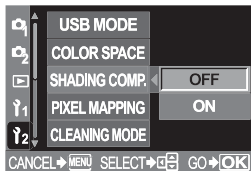

### Notes

- This function is not available when a tele converter or inner tube extension is attached to the camera.
- At higher ISO settings, noise in image edges may be conspicuous.

## Noise reduction

This function reduces the noise that is generated during long exposures. When shooting night scenes, shutter speeds are slower and noise tends to appear in images. When [NOISE REDUCTION] is set to [ON], the camera automatically reduces noise to produce clearer images. However, shooting time is approximately twice as long as usual.

For more information about noise generated in images during long exposures, refer to P. 46.



OFF



ON

1 Menu ▸ [ ] ▸ [NOISE REDUCTION] ▸ [ON]

2 Press the button.

3 Take the picture.

- The noise-reduction process is activated after shooting.
- The card access lamp blinks during the noise-reduction process. You cannot take more pictures until the card access lamp goes out.
- [busy] is displayed on the viewfinder while noise reduction is operating.

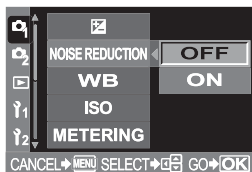

### Notes

- When the [SCENE] mode is set to , [NOISE REDUCTION] is fixed to [ON].
- When [NOISE REDUCTION] is set to [ON], sequential shooting is not available.
- This function may not work effectively with some shooting conditions or subjects.



## Color space

This function lets you select how colors are reproduced on the monitor or printer. The first character in image file names indicates the current color space.  "File name" (P. 131)

Pmdd0000.jpg  
└──┬── P: sRGB  
    └── \_: Adobe RGB

[sRGB] Standardized color space for Windows

[Adobe RGB] Color space that can be set by Adobe Photoshop

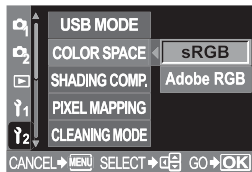

- 1 Menu ▸ [] ▸ [COLOR SPACE]
- 2 Use  to select [sRGB] or [Adobe RGB].
- 3 Press the  button.



## 6

## Anti-shock

This diminishes camera shake caused by vibrations when the mirror moves. You can select the interval from the time the mirror is raised until the shutter is released.

- 1 Menu ▸ [] ▸ [ANTI-SHOCK]
- 2 Use  to select [OFF] or [1SEC] - [30SEC].
- 3 Press the  button.

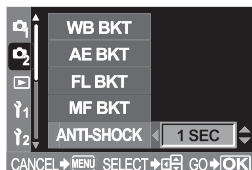

# 7

## Playback

One of the big advantages of a digital camera is that as soon as you take a picture, you can see how it looks right away. That means that if the picture is out of focus or just hasn't turned out the way you want, you can erase it and try again. With a film camera, on the other hand, you won't know if there is a problem with the picture until you get the film developed. Because a digital camera lets you erase those unwanted images, you can keep more memory free to store images and take more shots. You can also protect images that you do not want to erase.

Another benefit is that you can edit recorded images: change colors to black and white or sepia, change the resolution, attach to e-mail, etc. So take advantage of your digital camera's benefits and have fun taking great pictures.

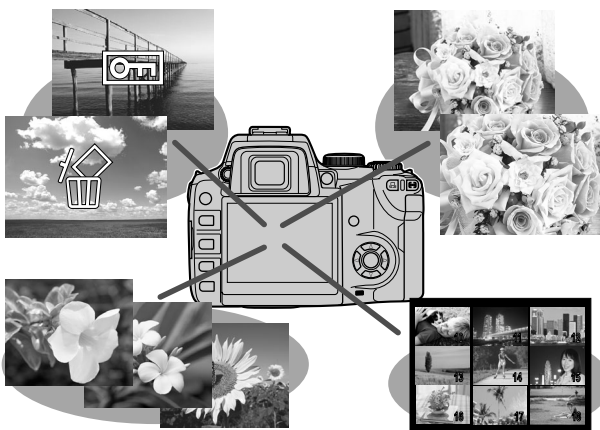

# Single-frame playback

There are several different ways to view and edit images. However, before using any of these functions, follow step 1 below.

## 1 Press the (playback) button.

- The monitor turns off after about 1 minute if no operations are performed. After about 1 hour without being used, the camera will turn off automatically. Turn on the camera again.

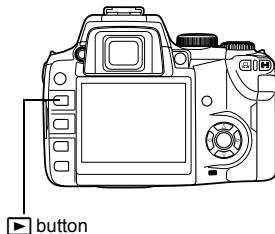

The last recorded image appears.



7

Playback

## 2 Use to select images you want to view.

 Displays the frame that is stored 10 frames back.

 Displays the previous frame.





 Displays the next frame.

 Displays the frame that is stored 10 frames ahead.

- To exit the playback mode, press the  button.
- Pressing the shutter button halfway resumes the shooting mode.





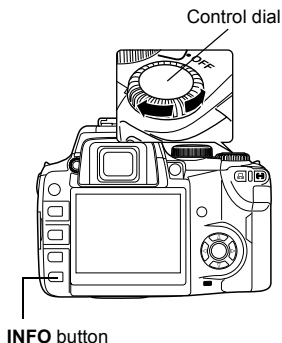

This function lets you enlarge images displayed on the monitor. This is useful when you want to check the details in an image.

- 1 Each time you rotate the control dial  toward **Q**, the image is enlarged in steps of 2x - 14x.
  - Rotating the control dial  toward  restores the previous image size.



## Changing close-up position

- 1 During close-up playback, use  in the direction you want to move.
  - If the image reaches the end,     disappears.



## Displaying close-up position

- 1 Press the INFO button during close-up playback.
  - The part you have enlarged is displayed with a frame.





## Frame-by-frame playback during close-up

- 1 Press the INFO button.
- 2 Use  to select images you want to view.
- 3 To apply close-up to the image or return to the original size, press the INFO button.

## Light box display

You can view multiple images simultaneously during close-up ( P. 99). This is useful if you want to check images you recorded using bracketing.

**1 Press the  (one-touch WB) button during single-frame playback. The image is enlarged by 10 times and displayed within a frame.**

- Use  to select the part of the picture you want to enlarge and press the  button again. Close-up playback is possible.

**2 Press the  (AF frame selection) button.**

- The frame that you enlarge first will be displayed in the left half of the screen, and the next frame will be enlarged with the same magnification in the right half of the screen.

**3 Use  to select an image.**

- You can protect, erase or copy the image.

**4 Press the  button to return to close-up single-frame playback.**

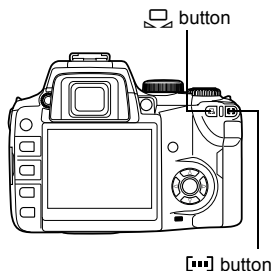

### Notes





- It is not possible to change the magnification during light box display.





This function lets you show several images on the monitor at the same time. This is useful when you want to quickly search a number of pictures to find a particular image.

**1 Each time you rotate the control dial toward , the number of images shown changes from 4 to 9 to 16 to 25.**

- : Moves to the previous frame.
- : Moves to the next frame.
- : Displays the index previous to the top-left image in the currently displayed index.
- : Displays the index proceeding the lower-right image in the currently displayed index.

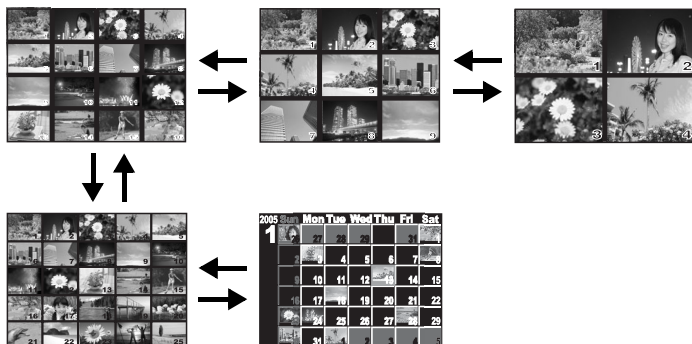
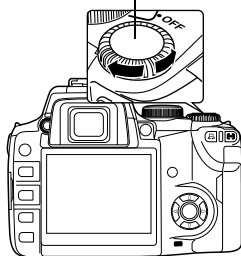

Control dial



Calendar display (  P. 102 )

## Calendar display

With the calendar, you can display images recorded on the card by date. If more than one image was taken on a single date, the image shot first on that date is displayed.

- 1 During index display (P. 101), rotate the control dial  toward  until the calendar screen is displayed.

Control dial

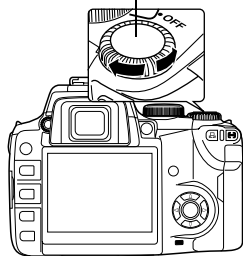

- 2 Use  to select images you want to view.

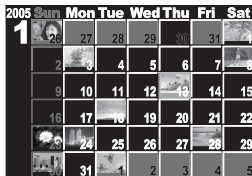

7

Playback

This allows you to display detailed information about the image. Luminance information can also be displayed with histogram and highlight graphs.

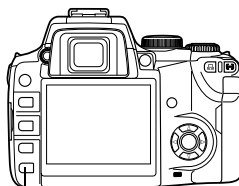

INFO button

## 1 Press the INFO button repeatedly until the desired information is displayed.

- This setting is stored and will be shown the next time the information display is called up.

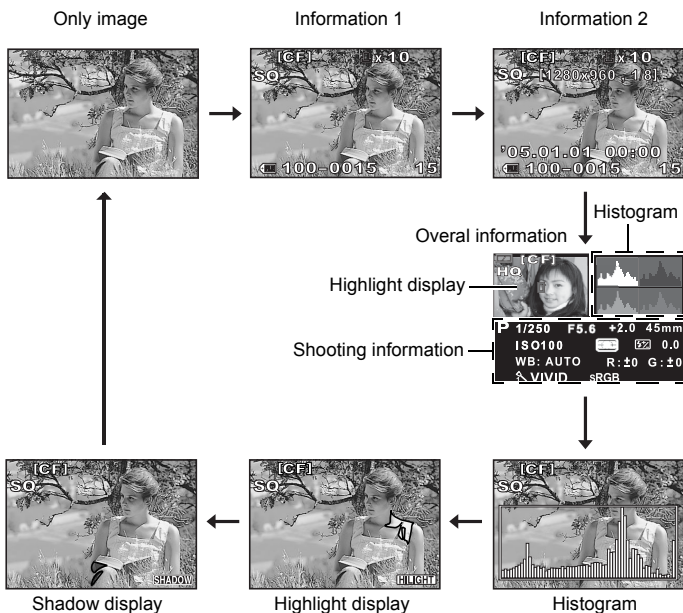

## Information 1

Frame number, print reservation, protect, record mode, number of pixels and file number.



## Information 2

Frame number, print reservation, protect, record mode, compression, date and time and file number.



# 7

Playback

## Histogram

Shows you the distribution of brightness in recorded images. Checking the histogram will enable more precise exposure control for subsequent shots. Record mode is also displayed.

### How to use the histogram display

The histogram display enables you to check the brightest highlights and darkest shadows which may result in a poor image. If the bars in the histogram are higher towards the right, the image may be too bright. If the bars are higher on the left, the image may be too dark. Compensate the exposure or shoot again.

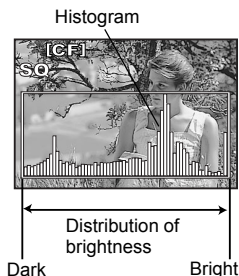

## Highlight display

The overexposed (highlighted) parts of the recorded image blink. Record mode is also displayed.



Overexposure

## Shadow display

The underexposed (shadowed) parts of the recorded image blink. Record mode is also displayed.



Underexposure

## Overall information

Displays shooting information, histogram and highlight simultaneously.

Highlight display

Histogram

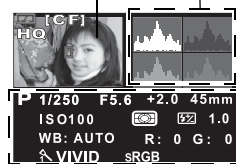

Shooting information

# Slideshow

This function displays images stored on the card one after another. Images are displayed one by one for about 5 seconds starting from the currently displayed image. Slideshow can be performed using index display. You can select the number of images displayed during slideshow from 1, 4, 9, 16 or 25.

**1** Menu ▸ [▶] ▸ [🖼️]

**2** Use [🔘] to set.

[🖼️1] Single-frame playback

[🖼️4] Playback of 4 frames

[🖼️9] Playback of 9 frames

[🖼️16] Playback of 16 frames

[🖼️25] Playback of 25 frames

**3** Press the [OK] button to start the slideshow.

**4** Press the [OK] button to stop the slideshow.





When selecting [🖼️4]

## Notes

- If the slideshow is left running for about 30 minutes, the camera will turn off automatically.

## Rotating images

This function lets you rotate images and display them vertically on the monitor. This is useful for viewing pictures that were taken with the camera held vertically.

- 1 Menu ▶ [▶] ▶ [📷] ▶ [ON]
- 2 Press the  button.
- 3 Each time the  (exposure compensation) button is pressed, the image is rotated.
  - The rotated image will be recorded on the card.

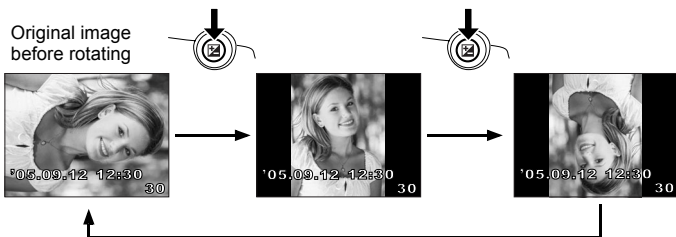
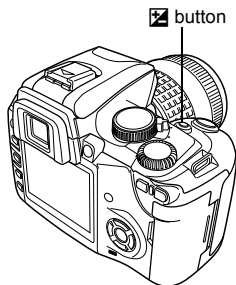

## Playback on TV

Use the video cable provided with the camera to play back recorded images on your TV.

- 1** Turn the camera and TV off, and connect the video cable as illustrated.
- 2** Turn on the TV and set it to the video input mode. For details on switching to the video input mode, refer to the TV's instruction manual.
- 3** Turn the camera on and press the  (playback) button.

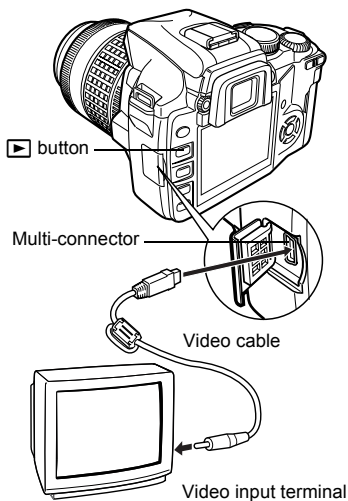

7

Playback

### Notes

- To connect the camera to a TV, use the provided video cable.
- Make sure that the camera's video output signal type is the same as the TV's video signal type.  "Selecting the video signal type before TV connection" (P. 135)
- The camera's monitor turns off automatically when the video cable is connected to the camera.
- The image may appear off-center depending on the TV screen.



## Editing still images

Recorded images can be edited and saved as new images. Available editing functions depend on the image format (image record mode). A JPEG or TIFF file can be printed as is without modification. A RAW file, on the other hand cannot be printed as is. To print a RAW file, use the RAW edit function to convert the RAW data format to JPEG.

### **Editing images recorded in RAW data format**

The camera performs image processing (such as white balance and sharpness adjustment) on images in the RAW data format, then saves the data to a new file in the TIFF or JPEG format. While checking recorded images, you can edit them to your liking.

**Image processing is performed based on the current camera settings. If you want to use different settings when editing, change the current camera settings beforehand.**

### **Editing images recorded in JPEG/TIFF data format**

- |   |   |
|---|---|
| [BLACK & WHITE]   | Creates black and white images.                                     |
| [SEPIA]   | Creates sepia-toned images.   |
| [REDEYE FIX]  | Reduces red-eye phenomenon during flash shooting.                   |
| [SATURATION]  | Sets the color depth.   |
| [  | Converts the image file size to 1280 x 960, 640 x 480 or 320 x 240. |





Image in RAW data format



Image in JPEG/TIFF data format





### Notes

- The image recorded in TIFF is saved as an SHQ image.

- 1 Menu ▸ [▶] ▸ [EDIT]
- 2 Use  to select images you want to view. Press the  button.
  - The camera recognizes the image data format.
- 3 The setting screen varies depending on the image data format. Select the data you want to edit and do the following steps depending on the image data format.



When editing JPEG/TIFF image  
[BLACK & WHITE] / [SEPIA] /  
[REDEYE FIX] / [SATURATION] /  

SEPIA	 P. 111
REDEYE FIX	 P. 111
SATURATION	 P. 111
	 P. 112

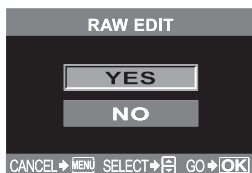



When editing RAW image  
RAW editing is based on the  
camera's current settings. Set the  
camera to suit your preferences  
before shooting.





## 7

## Playback

## RAW data edit

- 1 Use  to select [YES].
- 2 Press the  button.
  - To edit another image, use  to select the desired image.
  - To complete editing, press the **MENU** button.

## BLACK & WHITE

- 1 Use  to select [BLACK & WHITE]. Press the  button.
- 2 Use  to select [YES]. Press the  button.
  - To edit another image, use  to select the desired image.
  - To complete editing, press the **MENU** button.

## SEPIA

- 1 Use to select [SEPIA]. Press the button.
- 2 Use to select [YES]. Press the button.
  - To edit another image, use to select the desired image.
  - To complete editing, press the **MENU** button.

## REDEYE FIX

- 1 Use to select [REDEYE FIX]. Press the button.
  - After the [BUSY] bar is displayed, the areas targeted for correction are framed in blue.
- 2 Use to select [YES]. Press the button.
  - To edit another image, use to select the desired image.
  - To complete editing, press the **MENU** button.

### Notes







- Red-eye correction does not work on images recorded in RAW or TIFF.
- Red-eye correction may not work depending on the image. Red-eye correction may affect other parts of the image, as well as the eyes.



## SATURATION

- 1 Use to select [SATURATION]. Press the button.
- 2 Use to adjust the brightness.  
Press the button.
- 3 Use to select [YES]. Press the button.
  - To edit another image, use to select the desired image.
  - To complete editing, press the **MENU** button.



## Resizing

- 1 Use   to select . Press the  button.
- 2 Use   to select the number of pixels, then press the  button.

- The [BUSY] bar is displayed when editing is in progress.
- The resized image is saved as a new image.
- To edit another image, use   to select the desired image.
- To complete editing, press the **MENU** button.

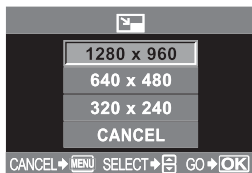

### Notes

- Resizing is not possible in the following cases:  
When an image is recorded in RAW, when an image is processed on a PC, when there is not enough space in the card memory, when an image is recorded on another camera.
- When resizing an image, you cannot select a larger number of pixels than were originally recorded.

## Copying images







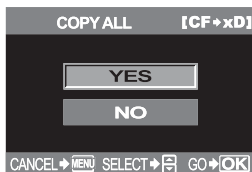

This function lets you copy images to and from the xD-Picture Card and CompactFlash or Microdrive. This menu can be selected if both cards are inserted. The selected card is the copying source.

### Copying all the frames

- 1 Menu ▸ [▶] ▸ [COPY ALL]
- 2 Press the  button.
- 3 Use   to select [YES].
- 4 Press the  button.





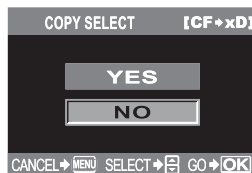
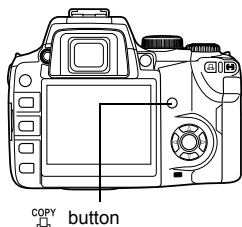

### Copying selected frames

- 1 Press the  button during playback.
- 2 When the image selection screen is displayed, use   to select the images you want to copy and press the  button.
  - The selected images will be shown with red frames.
  - To cancel your selection, press the  button again.
- 3 After you have selected the images to copy, press the  (copy) button.
- 4 Use   to select [YES]. Press the  button.
  - To finish copying, press the **MENU** button.
  - It is possible to copy selected frames during index display.



### Single-frame copy

- 1 Select the desired frame and press the  button.
- 2 Use   to select [YES]. Press the  button.



Protect images you do not want to erase. Protected images cannot be erased by the selected frame/all-frame erase function.

- 1 Play back the image you want to protect. P. 98
- 2 Press the **AEL/AFL/O<sub>PI</sub>** (protect) button.
  - is displayed on the screen.

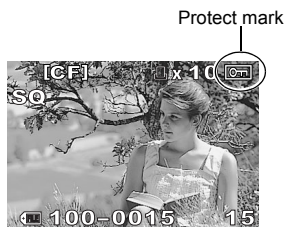
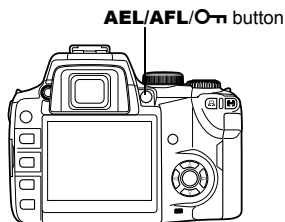

## 7

Playback

### To cancel the protection

Display the images that are protected and press the **AEL/AFL/O<sub>PI</sub>** button.

### Notes

- Formatting the card erases all images even if they have been protected. P. 26
- Protected images cannot be rotated.

## Erasing images





Lets you erase recorded images. You can select either single-frame erase, which erases only the currently displayed image, or all-frame erase, which erases all the images stored on the card.

### Notes

- Protected images cannot be erased. Cancel protected images, then erase them.
- Once erased, images cannot be restored.  "Protecting images — Preventing accidental erasure" (P. 114)



## Single-frame erase



- 1 Play back the image you want to erase.
- 2 Press the  (erase) button.
- 3 Use   to select [YES]. Press the  button.

### TIPS



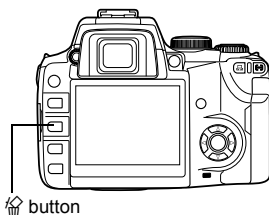

To erase immediately:

- If you have set [QUICK ERASE] ( P. 130) to ON, pressing the  button will erase an image immediately.



## All-frame erase



- 1 Menu  []  [CARD SETUP]
- 2 Use  to select [ALL ERASE]. Press the  button.

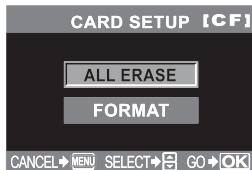

- 3** Use to select [YES]. Press the button.
- All frames will be erased.



## Erasing selected frames

This function lets you erase selected pictures at one time during index display. You can select multiple images to erase during single-frame playback.

- 1** Bring up the index display. P. 101
- 2** Use to select the images you want to erase, and press the button.
  - The selected images will be shown with red frames.
  - Press the button to cancel your selection.
- 3** After you have selected the frame to erase, press the (erase) button.
- 4** Use to select [YES].
- 5** Press the button.

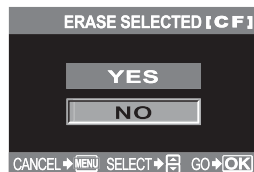

### Priority setting

In the  $\uparrow_2$  menu, [PRIORITY SET] ( P. 129) allows you to set the screen cursor setting to [YES].

### Quick erase

In the  $\uparrow_1$  menu, [QUICK ERASE] ( P. 130) allows you to erase an image immediately using the button.



## 8

## Customizing the settings/ functions of your camera

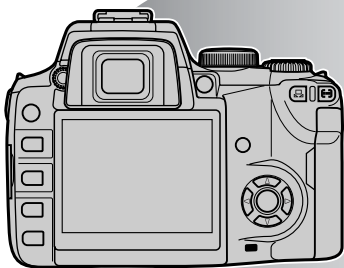

Thanks to digital technology you can effortlessly customize many of your camera's functions. For example, you can call up your favorite functions at the touch of a button, adjust EV step values, or easily call up the functions you customized. This chapter introduces all the functions that can be customized to suit preferences. Try these functions to find ways to use your camera even more effectively.



## Custom reset setting



Normally, current camera settings (including any changes you have made) are retained when the power is turned off. This camera allows you to restore the factory default settings using [RESET] and register 2 different reset settings in [RESET1] and [RESET2] for later use.

### Registering reset settings

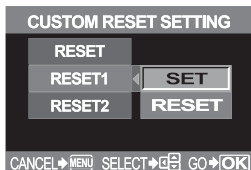
- 1 Menu ▶ [M] ▶  
[CUSTOM RESET SETTING]
- 2 Use  to set.  
[RESET1] / [RESET2]
  - If menu settings have already been registered, [SET] is displayed next to the corresponding reset option.
- 3 Use  to select [SET].
  - The current setting is displayed on the monitor.







#### Clearing already registered settings

- Use  to select [RESET].
- Registered settings are canceled.
- 4 Press the  button.





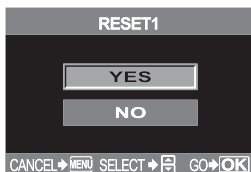

### Using reset settings

When the power is turned on, you can reset the camera to [RESET 1] or [RESET 2] setting or restore the factory default settings.

- 1 Menu ▶ [M] ▶  
[CUSTOM RESET SETTING]
- 2 Use  to set.  
[RESET] Resets to the factory default settings.  
[RESET 1]/[RESET 2] Resets to the registered settings.
- 3 Press the  button.
- 4 Use   to select [YES].
- 5 Press the  button.



**Functions that can be registered in CUSTOM RESET SETTING & functions that reset to factory default settings**

Function	Factory default setting	Custom reset setting registration	My Mode registration
PICTURE MODE	VIVID	✓	✓
GRADATION	NORMAL	✓	✓
	HQ	✓	✓
	±0	✓	✓
NOISE REDUCTION	OFF	✓	✓
WB	AUTO	✓	✓
ISO	AUTO	✓	✓
METERING	ESP	✓	✓
FLASH MODE	Auto-flash* <sup>1</sup>	✓	✓
		✓	✓
AF	S-AF	✓	✓
	AUTO	✓	✓
AE BKT	OFF	✓	✓
WB BKT	OFF	✓	✓
FL BKT	OFF	✓	✓
MF BKT	OFF	✓	✓
ANTI-SHOCK	OFF	✓	—
Playback mode	Single-frame playback (with no information)	—	—
ISO STEP	1/3EV	✓	—
ISO BOOST	OFF	✓	—
ISO LIMIT	OFF	✓	—
EV STEP	1/3EV	✓	—
ALL 	±0	—	—
HQ	1/8	✓	—
SQ	1280 × 960, 1/8	✓	—
MANUAL FLASH	OFF	✓	—
	OFF	✓	—
	1/180	✓	✓
AUTO POP UP	ON	✓	—
DIAL	P <sub>s</sub> * <sup>1</sup>	✓	—
AEL/AFL	mode1* <sup>2</sup>	✓	—
AEL/AFL MEMO	OFF	✓	—

Function	Factory default setting	Custom reset setting registration	My Mode registration
AEL METERING	Synchronized with metering mode.	✓	—
QUICK ERASE	OFF	✓	—
RAW+JPEG ERASE	RAW+JPEG	✓	—
 FUNCTION		✓	—
MY MODE SETUP	—	✓	—
FOCUS RING		✓	—
AF ILLUMINATOR	ON	✓	✓
RESET LENS	ON	—	—
RELEASE PRIORITY S	OFF	✓	✓
RELEASE PRIORITY C	ON	✓	✓
	2005.01.01 00:00	—	—
CF/xD	CF	—	✓
FILE NAME	AUTO	—	—
EDIT FILENAME	OFF	—	—
	0	—	—
	ENGLISH	✓	—
VIDEO OUT	*3	—	—
	ON	✓	—
REC VIEW	OFF	✓	—
SLEEP	1 MIN	✓	—
4h TIMER	4h	—	—
BUTTON TIMER	3 SEC	—	—
SCREEN	OFF	—	—
CTL PANEL COLOR	COLOR1	—	—
PRIORITY SET	NO	✓	—
USB MODE	AUTO	—	—
COLOR SPACE	sRGB	✓	—
SHADING COMP.	OFF	✓	✓
PIXEL MAPPING	—	—	—
CLEANING MODE	—	—	—
FIRMWARE	—	—	—

✓ : Can be registered.

— : Cannot be registered. When the [RESET1] / [RESET2] settings are used, functions indicated by "—" will retain their current settings. The factory default settings are not restored.

\*1 : Depending on the selected exposure mode, the factory default setting changes.

\*2 : Depending on the selected focus mode, the factory default setting changes.

\*3 : The factory default setting varies depending on the area where you purchased this camera.

## AEL/AFL mode

Functions performed when the shutter button is pressed halfway



- AF start
- Focus lock
- AE lock

can be assigned to the AEL button.

Examples:

- After locking focus, you lock exposure value to take a picture.
- After locking exposure value, you lock focus to take a picture.
- After locking exposure value and focus, you take a picture whenever the opportunity arises.

You can select modes in S-AF, C-AF and MF (☞ P. 70).

- 1** Menu ▶ [**1**] ▶ [AEL/AFL]
- 2** Use  to select the focus mode.  
[S-AF] / [C-AF] / [MF]
- 3** Use  to select the AEL/AFL mode.  
[S-AF] Selects from mode 1- mode 3.  
[C-AF] Selects from mode 1- mode 4.  
[MF] Selects from mode 1- mode 3.
- 4** Press the  button.

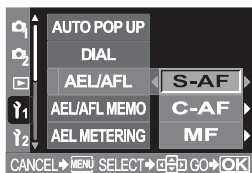

**Modes available in the S-AF mode**

Mode	Shutter button function				AEL button function	
	Half-press		Full press		When holding down AEL	
	Focus	Exposure	Focus	Exposure	Focus	Exposure
mode 1	Locked	Locked	–	–	–	Locked
mode 2	Locked	–	–	Locked	–	Locked
mode 3	–	Locked	–	–	Locked	–

**Modes available in the C-AF mode**

Mode	Shutter button function				AEL button function	
	Half-press		Full press		When holding down AEL	
	Focus	Exposure	Focus	Exposure	Focus	Exposure
mode 1	Focusing starts.	Locked	Locked	–	–	Locked
mode 2	Focusing starts.	–	Locked	Locked	–	Locked
mode 3	–	Locked	Locked	–	Focusing starts.	–
mode 4	–	–	Locked	Locked	Focusing starts.	–

**Modes available in the MF mode**

Mode	Shutter button function				AEL button function	
	Half-press		Full press		When holding down AEL	
	Focus	Exposure	Focus	Exposure	Focus	Exposure
mode 1	–	Locked	–	–	–	Locked
mode 2	–	–	–	Locked	–	Locked
mode 3	–	Locked	–	–	S-AF	–

## AEL/AFL memo

Pressing the **AEL** button toggles the AE lock between on and off.

- 1 Menu ▶ [**Y1**] ▶ [AEL/AFL MEMO]
- 2 Use **Q** to select [ON] or [OFF].
- 3 Press the **OK** button.

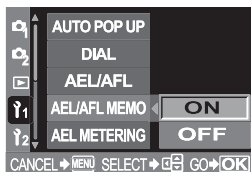

## AEL metering

Set the metering mode before using the **AEL** button to lock the exposure. This allows the camera to automatically apply the selected metering mode when the AE lock function is used (P. 81).

- 1 Menu ▶ [**Y1**] ▶ [AEL METERING]
- 2 Use **Q** to set.  
[AUTO] / [M] / [S] / [S HI] / [S SH]
- 3 Press the **OK** button.

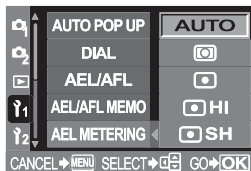

## EV step

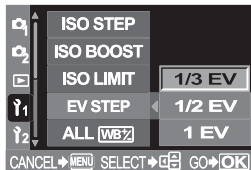

This allows you to change the EV step for exposure parameter setting, such as shutter speed, aperture value or exposure compensation value, etc.

- 1 Menu ▶ [**Y1**] ▶ [EV STEP]
- 2 Use **Q** to set.  
[1/3EV] / [1/2EV] / [1EV]
- 3 Press the **OK** button.



## ISO step

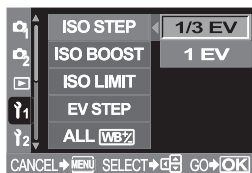

This allows you to change the compensation steps for ISO value setting.

- 1 Menu ▶ [ ] ▶ [ISO STEP]
- 2 Use  to set.  
[1/3EV] / [1EV]
- 3 Press the  button.



## ISO boost

This allows you to make ISO 800 - 1600 available for ISO setting in addition to ISO 100 - 400. [ON+NF] reduces noise at higher ISO values to produce clearer images.

- 1 Menu ▶ [ ] ▶ [ISO BOOST]
- 2 Use  to set.  
[OFF] / [ON+NF] / [ON]
- 3 Press the  button.

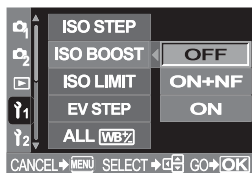



### Notes

- When [ISO BOOST] is set to [ON+NF], shooting time will be longer than usual.

## ISO limit

This allows you to set the maximum ISO to avoid image blur in bright environments.

- 1 Menu ▶ [ ] ▶ [ISO LIMIT]
- 2 Use  to set.  
[OFF] / [100] / [200] / [400] / [800]
- 3 Press the  button.

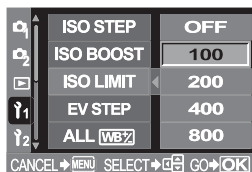



## Compensating all WB

This lets you apply the same compensation value to all the white balance modes at once.

1 Menu ▶ [**1**] ▶ [ALL **WB%**]

2 Use **OK** to set.

[ALL SET] The same compensation value applies to all WB modes.

[ALL RESET] The WB compensation value settings applied to each WB mode are all cleared at once.

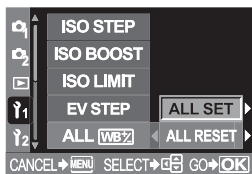

3 Press the **OK** button.

4 Do the following steps depending on the setting you want.

If you select [ALL SET]

1) Use **OK** to select the color direction.

R-B Red-Blue

G-M Green-Magenta

2) Use **←** **→** to set compensate value.

**WB Compensation** (P. 91)

- You can check the white balance you have adjusted.

If you select [ALL RESET]

1) Use **←** **→** to select [YES].

5 Press the **OK** button.

## Manual flash

This allows the built-in flash to output a fixed amount of light. With [MANUAL FLASH] set to [ON], you can set the amount of light (FULL, 1/4, 1/16, or 1/64) in the flash mode setting.

1 Menu ▶ [**1**] ▶ [MANUAL FLASH]

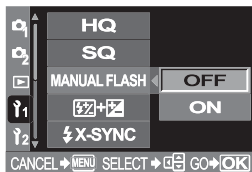

2 Use **OK** to select [ON] or [OFF].

3 Press the **OK** button.



## Speed synchronization

You can set the shutter speed that will be used when the built-in flash fires. The speed can be set from 1/60 to 1/180 in 1/3 EV increments.

- 1 Menu ▸ [1] ▸ [X-SYNC]
- 2 Use  to select the desired speed.
- 3 Press the  button.

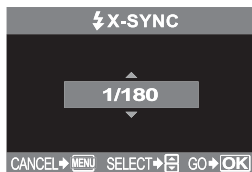



### Notes

- For details on the synchronization speed of commercially available flashes, refer to their manuals.

## Auto flash popup

When you take pictures in **AUTO**, ,  or  mode, the built-in flash will automatically pop up in low-light or backlit conditions. If you want to control the flash pop-up, set this function to OFF.

- 1 Menu ▸ [1] ▸ [AUTO POP UP]
- 2 Use  to select [ON] or [OFF].
- 3 Press the  button.

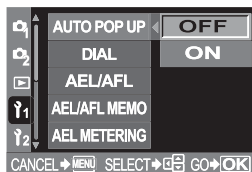

## Customizing the control dial's function

The control dial factory default settings are as follows:

### **P** Program shooting

Rotating the control dial : Program shift (**Ps**) setting

Rotating the control dial while holding down the  (exposure compensation) button : Exposure compensation setting

### **M** Manual shooting

Rotating the control dial : Shutter speed setting

Rotating the control dial while holding down the  (exposure compensation) button : Aperture value (f-number) setting

Setting [DIAL] enables the following:

**P** You can set exposure compensation simply by rotating the control dial.

**M** You can set aperture value simply by rotating the control dial.

### **1** Menu ▸ [] ▸ [DIAL]

### **2** Use to select [P] or [M].

#### If you select [P]

1) Use   to set.

[Ps] Program shift  
 Exposure compensation

#### If you select [M]

1) Use   to set.

[Fno.] Aperture setting  
[SHUTTER] Shutter speed setting

### **3** Press the button.

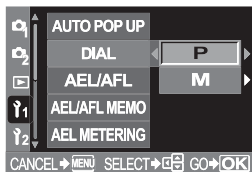

## button function

This lets you replace the function assigned to the  (one-touch WB) button by registering another function.

1 Menu ▶ [1] ▶ [ FUNCTION]



2 Use  to set.

 One-touch white balance button (factory-default setting)



### [TEST PICTURE]

This enables you to check the picture you have just taken on the monitor (REC VIEW feature) without having to record the picture to the card. This is useful when you want to see how a picture turned out before saving it.

### [MY MODE]

While holding down the  button, you can take pictures using the camera settings registered in the [MY MODE SETUP] ( See below).

### [PREVIEW]

While holding down the  button, you can use the preview function. ( P. 47)

3 Press the  button.

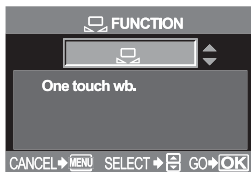

## 8

## My Mode setting

You can register 2 different combinations of camera settings and temporarily call up one of the registered settings while taking pictures. The registered setting can be used while the  (one-touch WB) button is being pressed.

1 Menu ▶ [1] ▶ [MY MODE SETUP]

2 Use  to set.

[MY MODE1] / [MY MODE2]

- If menu settings have already been registered, [SET] is displayed next to the corresponding reset option.

3 Use  to select [SET].

- The current setting is displayed on the monitor.

### Clearing already registered settings

Use  to select [RESET].

- Registered settings are canceled.

4 Press the  button.

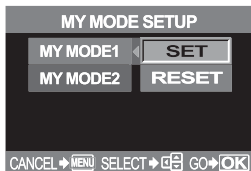

## Reset lens

This allows you to reset the focus of the lens (infinity) when the power is turned off.

- 1 Menu ▶ [ $\mathcal{I}$ 1] ▶ [RESET LENS]
- 2 Use  $\odot$  to select [ON] or [OFF].
- 3 Press the  $\odot$  button.

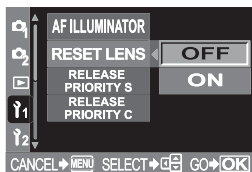

## Focus ring

This allows you to customize how the lens adjusts to the focal point by selecting the rotational direction of the focus ring.

- 1 Menu ▶ [ $\mathcal{I}$ 1] ▶ [FOCUS RING]
- 2 Use  $\odot$  to select [ $\curvearrowright$ ] or [ $\curvearrowleft$ ].

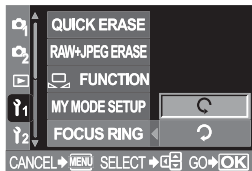

- 3 Press the  $\odot$  button.

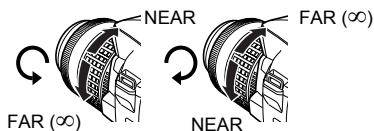

## Priority setting

This allows you to customize the cursor position (YES or NO) as the initial position on the [ALL ERASE], [ERASE] or [FORMAT] screen.

- 1 Menu ▶ [ $\mathcal{I}$ 2] ▶ [PRIORITY SET]
- 2 Use  $\odot$  to select [YES] or [NO].

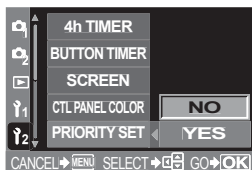



## Quick erase

This lets you erase the picture you have just taken immediately using the  (erase) button.

**1** Menu ▸ [Y1] ▸ [QUICK ERASE]

**2** Use  to set.

[OFF] When the  button is pressed, the confirmation screen appears, asking you if you want to erase the picture.

[ON] Pressing the  button erases the picture immediately.

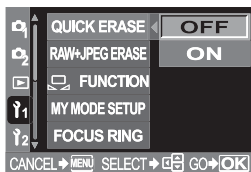

**3** Press the  button.

## Erasing RAW and JPEG files

This lets you select which type of file to erase when erasing a single frame on the card.

**1** Menu ▸ [Y1] ▸ [RAW+JPEG ERASE]

**2** Use  to set.

[JPEG] Erases all JPEG image files.

[RAW] Erases all RAW image files.

[RAW+JPEG] Erases all RAW and JPEG image files at the same time.

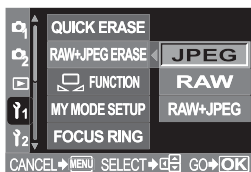

**3** Press the  button.

## File name

When you take a picture, the camera assigns it a unique file name and saves it in a folder. The folder and file name can later be used for file handling on a computer.

File names are assigned as shown in the illustration below.

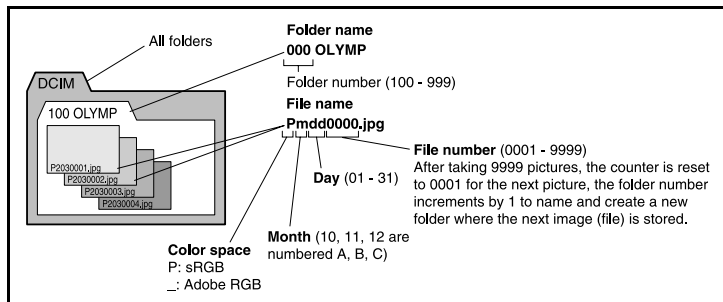

### 1 Menu ▶ [ ] ▶ [FILE NAME]

### 2 Use to set.

- [AUTO]** Even when a new card is inserted, the folder numbers are retained from the previous card. If the new card contains an image file whose file number coincides with one saved on the previous card, the new card's file numbers start at the number following the highest number on the previous card.
- [RESET]** When a new card is inserted, folder numbers start at 100 and file numbers start at 0001. If a card containing images is inserted, the file numbers start at the number following the highest file number on the card.

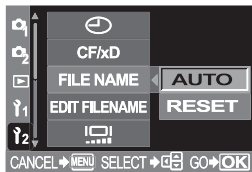

### 3 Press the button.

#### Notes

- When both the Folder and File No. reach their respective maximum number (999/9999), it is not possible to store additional pictures even if the card is not full. No more pictures can be taken. Replace the card with a new one.

## Rename file

You can rename image files to make them easier to identify and organize.

- 1 Select [sRGB] or [Adobe RGB]. P. 96
- 2 Menu  $\blacktriangleright$  [  $\mathcal{Y}$ 2 ]  $\blacktriangleright$  [EDIT FILENAME]
- 3 Use to enter the first character. Press to move to the next setting, then use to enter the second character.

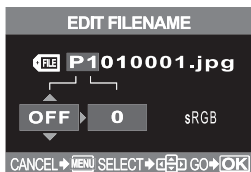

sRGB:Pmdd0000.jpg

AdobeRGB:\_mdd0000.jpg

You can change the first character to OFF, A - Z or 0 - 9.

- 4 Press the button.

## Rec view - Checking the picture immediately after shooting

This allows you to display the picture you have just taken on the monitor while it is being recorded to the card, and to select how long the picture is displayed. This is useful for making a brief check of the picture you have just taken. Pressing the shutter button halfway during REC VIEW lets you resume shooting immediately.



- 1 Menu  $\blacktriangleright$  [  $\mathcal{Y}$ 2 ]  $\blacktriangleright$  [REC VIEW]
- 2 Use to set.
  - [OFF] The picture being recorded to the card is not displayed.
  - [1 SEC] - [20 SEC] Selects the number of seconds to display each picture. Can be set in units of 1 second.
- 3 Press the button.





## Setting the warning tone

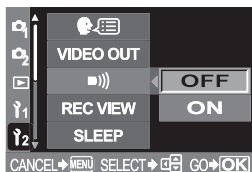

The camera beeps when buttons are pressed. It also beeps to alert you to warnings. You can turn the beep sound on or off with this function.

- 1 Menu ▶ [Y2] ▶ [Mute]
- 2 Use  to select [ON] or [OFF].
- 3 Press the  button.



## Monitor brightness adjustment

This allows you to adjust the brightness of the monitor for optimal viewing.

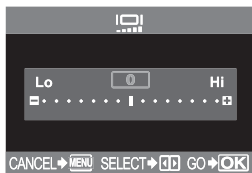

- 1 Menu ▶ [Y2] ▶ [Monitor]
- 2 Use  to adjust the brightness.
- 3 Press the  button.



## Sleep timer

After a specified period of time elapses with no operations being performed, the camera enters the sleep mode (stand-by) to save battery power. SLEEP lets you select sleep timer. [OFF] cancels the sleep mode.

The camera activates again as soon as you touch any button (the shutter button, arrow pad etc.)

- 1 Menu ▶ [Y2] ▶ [SLEEP]
- 2 Use  to set.  
[OFF] / [1 MIN] / [3 MIN] / [5 MIN] / [10 MIN]
- 3 Press the  button.

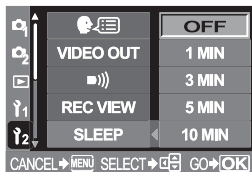

You can connect the camera directly to a computer or printer with the provided USB cable. If you specify the device you are connecting to beforehand, you can skip the USB connection setting procedure normally required every time you connect the cable to the camera. For details on how to connect the camera to either device, refer to Chapter 9 "Printing" (P. 139) and Chapter 10 "Transferring images to a computer" (P. 152).

### 1 Menu ▶ [ ]2▶ [USB MODE]

### 2 Use to set.

**[AUTO]** The selection screen for the USB connection will be displayed every time you connect the cable to a computer or printer.

**[STORAGE]** Allows USB connection to a PC and transfer of data to the PC. Also, select to use the OLYMPUS master software via PC connection.

**[CONTROL]** Allows you to control the camera from a PC using the optional OLYMPUS Studio.

**[ EASY]** Can be set when connecting the camera to a PictBridge-compatible printer. Pictures can be printed directly without using a PC.

 "Connecting the camera to a printer" (P. 146)

**[ CUSTOM]** Can be set when connecting the camera to a PictBridge-compatible printer. You can print out pictures with set number of prints, print paper and other settings.

 "Connecting the camera to a printer" (P. 146)

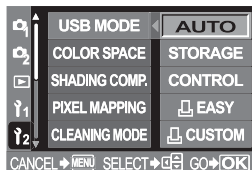

## Changing the display language

You can change the language used for the on-screen display and error messages from ENGLISH to another language.

- 1 Menu ▸ [ ]2 ▸ [🗨️]
- 2 Use [🗨️] to select the language you want to use.
- 3 Press the [OK] button.
  - You can add another language to your camera with the provided OLYMPUS Master software.  
For details, refer to Help.

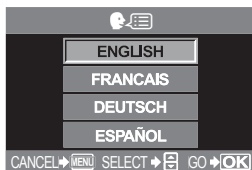

## Selecting the video signal type before TV connection

This lets you select NTSC or PAL according to your TV's video signal type. You'll need to set this when you want to connect the camera to a TV and play back images in a foreign country. Make sure the correct video signal type is selected before connecting the video cable. If you use the wrong video signal type, recorded pictures will not play back properly on your TV.

- 1 Menu ▸ [ ]2 ▸ [VIDEO OUT]
- 2 Use [🗨️] to select [NTSC] or [PAL].
- 3 Press the [OK] button.

### TV video signal types & main regions

Check the video signal type before connecting the camera to your TV.

NTSC	North America, Japan, Taiwan, Korea
PAL	European countries, China

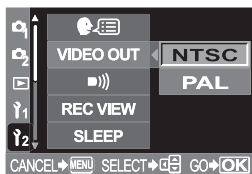

## Button timer

You can specify the operable time for function settings on the current setting screen from the time you take your finger away from any operation button.

**1** Menu ▶ [ ] ▶ [BUTTON TIMER]

**2** Use  to set.

**[3 SEC]** You will have 3 seconds to complete function setting on the current setting screen.

**[5 SEC]** You will have 5 seconds to complete function setting on the current setting screen.

**[HOLD]** You can take as long as you like to complete function setting. The current screen will remain until you press the button again.

**3** Press the  button.

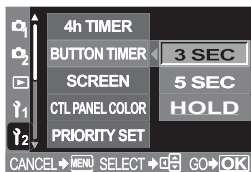

## Auto power off

This camera automatically turns off to reduce battery consumption if it is not operated for 4 hours. When you need to use the camera for a long time, you can reset this battery-saving function.

**1** Menu ▶ [ ] ▶ [4h TIMER]

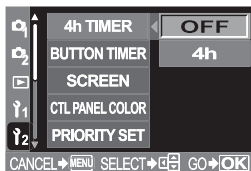

**2** Use  to select [OFF] or [4h].

**3** Press the  button.



## Start-up screen

When the camera is turned on, the control panel is displayed on the monitor right after the start-up screen. If you do not want the start-up screen to appear, set this function to [OFF].

- 1 Menu ▶ [ ] ▶ [SCREEN]
- 2 Use  to select [ON] or [OFF].
- 3 Press the  button.

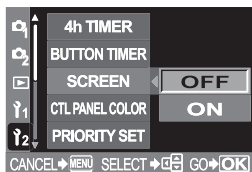

## Changing monitor color

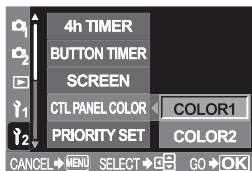

You can change the background color of the monitor.

- 1 Menu ▶ [ ] ▶ [CTL PANEL COLOR]
- 2 Use  to select [COLOR1] or [COLOR2].
- 3 Press the  button.



## Firmware

When you make inquiries about your camera or accessories or when you want to download software, you will need to inform which version of each the products you are using.

- 1 Menu ▶ [ ] ▶ [FIRMWARE]
- 2 Press . Your product's firmware version will be displayed.
- 3 Press the  button to return to the previous screen.



## Setting the date/time

Date and time information is recorded on the card together with the images. The file No. is also included with the date and time information. Be sure to set the correct date and time before using the camera.

**1** Menu ▶ [1/2] ▶ [⏪]

**2** Use [⏪] to select one of the following date formats: Y-M-D (Year/Month/Day), M-D-Y (Month/Day/Year), D-M-Y (Day/Month/Year). Then press [⏪].

- The following steps show the procedure used when the date and time settings are set to Y-M-D.



**3** Use [⏪] to set the year, then press [⏪] to move to the month setting.

- To return to the previous setting, press [⏪].
- The first two digits of the year are fixed.

**4** Repeat this procedure until the date and time are completely set.

- The time is displayed in the 24-hour format. For example, 2 p.m. will be displayed as 14:00.



**5** Press the [OK] button.

- For a more accurate setting, press [OK] when the time signal hits 00 seconds. The clock starts when you press the button.

### Notes

- The date and time settings will be returned to the factory default settings if the camera is left without the battery for approximately 1 day. The settings will be canceled more quickly if the battery was only loaded in the camera for a short time before being removed. Before taking important pictures, check that the date and time settings are correct.

# 9

## Printing

Let's print your shots!

You can print your images at photo labs or on your own printer. If you print at photo labs, you'll find the print reservation function helpful. Print reservation allows you to save the number of prints and the date and time information on the card.

If you print on a printer, there are a number of different ways to do it. One method is to connect your digital camera to an exclusive printer and print out recorded pictures directly from the camera. The other is to transfer images to a computer and print them on a printer connected to the computer.

### Printing with print reservation (DPOF)

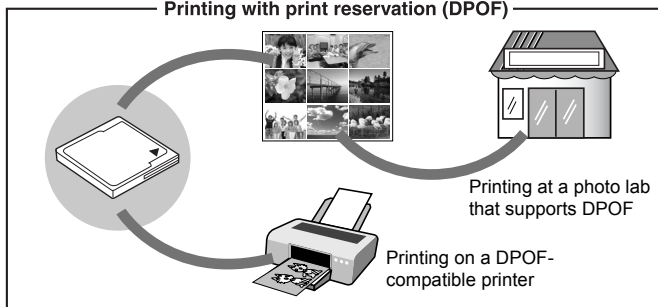

### Direct printing (PictBridge) or printing using a computer

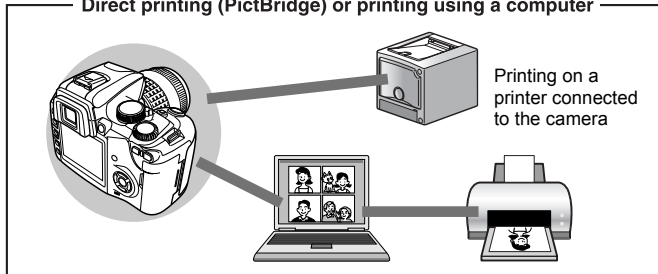



Print reservation allows you to save printing data (the number of prints and the date/time information) with the pictures stored on the card.

DPOF is a standard format used to record automatic print information from digital cameras. You can print out pictures automatically, at home or in a photo lab, by storing such data as which pictures you wish to print and the number of prints on a card.

Pictures set with print reservation can be printed using the following procedures.

### **Printing using a DPOF-compatible photo lab**

You can print the pictures using the print reservation data.

### **Printing using a DPOF-compatible printer**

Printing is possible directly from a card containing print reservation data without using a PC. For more details, refer to the printer's instruction manual.

A PC card adapter may also be necessary depending on the printer.

### **Picture size and printing**

The resolution of a computer/printer is generally based on the number of dots (pixels) per square inch. This is called dpi (dots per inch). The higher the dpi value, the better the printed results. Keep in mind, however, that the dpi of the picture does not change. This means that when you print an image with a higher resolution, the size of the printed picture will be smaller. Although you can print magnified images, picture quality will decrease.



If you want to print large, high-quality pictures, set the record mode as high as possible when taking the pictures.  "Selecting the record mode" (P. 29)

### **Notes**



- DPOF reservations set by another device cannot be changed by this camera. Make changes using the original device.
- If a card contains DPOF reservations set by another device, entering reservations using this camera will erase the previous reservations.
- If there is not enough space in the card memory, CARD FULL will be displayed and you may not be able to enter the reservation data.
- You can make DPOF print reservations for up to 999 images per card.
- Not all functions may be available on all printers or at all photo labs.
- Print reservation may take considerable time when saving printing data to a card.



## Flowchart for print reservation

There are two print reservation modes available: single-frame reservation  or all-frame reservation .

Set the camera to playback mode ( P. 98), then set the following.

Menu ▶  ▶ 

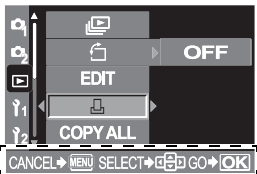

Follow the operation guide displayed here.

Select the print reservation mode.

 P. 142

Select frames you want to print  
(only for when you have selected .

 P. 142

Set the printing data.

 P. 142

Confirm the print reservation you have set.

 P. 143

## Selecting the print reservation mode



Select whether to apply print reservation to selected pictures or apply print reservation to all the pictures stored on the card.

- Applies print reservation to selected pictures.
- Applies print reservation to all the pictures stored in the card.  
Pictures shot after performing all-frame reservation and stored on the same card will not be printed.

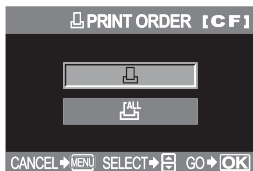

### ***If print reservation data is already stored on the card***

The RESET/KEEP selection screen appears, giving you the choice of resetting the data or keeping it.

- "Resetting print reservation" (P. 143)

## Selecting pictures you want to print

Lets you apply print reservation to selected pictures. Display the picture to be printed and select the desired number of prints. The number of prints can be set up to 10. If the number of prints is set to 0, print reservation will not be applied.

If all-frame reservation is used after single-frame reservation, specifications for the number of prints will be overwritten and only one copy of each frame will be printed.



## Setting printing data

You can print the shooting date and time on all the pictures selected for printing.

- [NO]** The pictures are printed without the date and time.
- [DATE]** All the selected pictures are printed with the shooting date.
- [TIME]** All the selected pictures are printed with the shooting time.

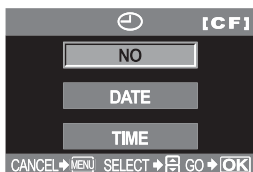

## Confirming your print setting

- [SET] Confirms the print reservation you have made.
- [CANCEL] Cancels the print reservation and the  menu is restored.

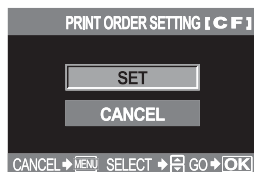

## Resetting print reservation

Lets you reset print reservation data. You can reset all print reservation data or just the data for selected pictures.

**1** Set the camera to playback mode. ( P. 98)

**2** Menu  $\blacktriangleright$    $\blacktriangleright$  

**3** Use  to select  or .

 Select this when you want to reset the print reservation data for a selected picture.



 Select this when you want to reset the print reservation data for all pictures.

**4** Press the  button.

- If print reservation data is already stored on the card, the RESET/KEEP selection screen appears, giving you the choice of resetting the data or keeping it.

**5** Do the following steps depending on the print reservation mode you have selected:

### Resetting the print reservation data for a selected picture

- 1) Use   to select [KEEP], then press .



- 2) Use to select the frame with print reservation data you want to reset, then press to set the number of prints to 0.

- To reset print reservation data of other frames, repeat this step.

- 3) Press when you are finished.

- The screen is displayed.

- 4) Use to select [NO], [DATE] or [TIME]. Press .

- This setting is applied to all frames with print reservation data.

- 5) Use to select [SET], then press .

- The setting is saved.
- The menu is restored.

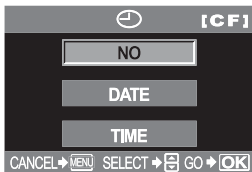

### Resetting the print reservation data for all pictures

- 1) Use to select [RESET], then press .

- 2) Press the **MENU** button.

- The menu is restored.



## Direct printing (PictBridge)

By connecting the camera to a PictBridge-compatible printer with the USB cable, you can print out recorded pictures directly. With the camera connected to the printer, select the pictures you want to print and the number of prints on the camera's monitor. It is also possible to print out pictures using the print reservation data (👉 P. 140).

To find out if your printer is compatible with PictBridge, refer to the printer's instruction manual.

### **PictBridge**

The standard that enables digital cameras and printers made by different manufacturers to be connected, and also allows pictures to be printed directly from the camera.

### **STANDARD**

All printers that support PictBridge have standard print settings. By selecting [🖨️ STANDARD] on the settings screens (👉 P. 149), you can print pictures according to these settings. For details on your printer's standard settings, refer to the printer's instruction manual or contact the printer manufacturer.

### **Printer accessories**

For details on printing paper types, ink cassettes, etc., refer to the printer's instruction manual.

#### **📌 Notes**

- Keep an eye on the battery remaining power. If you use the battery, make sure that it is fully charged. If the camera stops operating while communicating with the printer, the printer may malfunction or image data may be lost.
- Images recorded in RAW data cannot be printed.
- The camera will not enter sleep mode while it is connected to the USB cable.

## Connecting the camera to a printer

Use the USB cable provided to connect the camera to a PictBridge-compatible printer.

### 1 Turn the printer on and plug the printer end of the USB cable into the printer's USB port.

- For details on how to turn the printer on and the position of the USB port, refer to the printer's instruction manual.

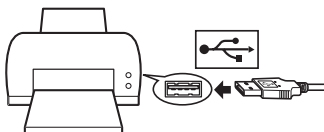

### 2 Plug the USB cable into the camera's multi-connector and turn the camera on.

- The selection screen for the USB connection is displayed.

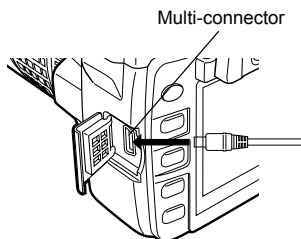

### 3 Use to select [EASY] or [CUSTOM].

#### If you select [EASY]

Go to "Easy printing" (P. 147).

#### If you select [CUSTOM]

ONE MOMENT is displayed and the camera and printer are connected. The PRINT MODE SELECT screen is displayed on the monitor. Go to "Flowchart for custom printing" (P. 147).

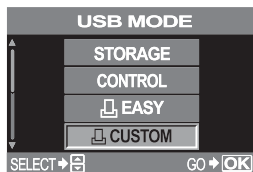

### Notes

- If the screen is not displayed after a few minutes, turn off the camera and start again from Step 2.

## Easy printing

- 1 Display the image you want to print.
- 2 Press the  (print) button.

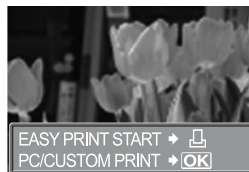

## Flowchart for custom printing

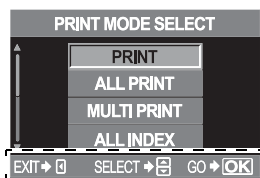

Follow the operation guide displayed here.

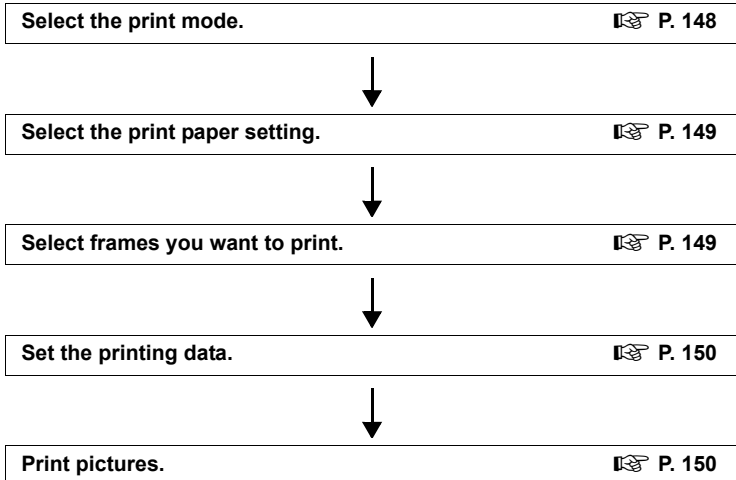

## Selecting the print mode

Select the type of printing (print mode). You can print pictures one by one or multiple pictures on a single sheet of paper.

<b>[PRINT]</b>	Prints selected pictures.
<b>[ALL PRINT]</b>	Prints all the pictures stored in the card and makes one print for each picture.
<b>[MULTI PRINT]</b>	Prints multiple copies of one image in separate frames on a single sheet.
<b>[ALL INDEX]</b>	Prints an index of all the pictures stored in the card.
<b>[PRINT ORDER]</b>	Prints according to the print reservation you made. If there is no picture with print reservation, this is not available.

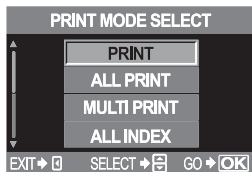

### Print modes and settings

The available print modes and settings such as paper size vary depending on the type of printer. For details, refer to the printer's instructions.



## Setting the print paper items

This setting varies depending on the type of printer. If only the printer's [  STANDARD ] setting is available, you cannot change the setting.

- [SIZE]** Sets the paper size that the printer supports.
- [BORDERLESS]** Selects whether the picture is printed on the entire page or inside a blank frame.
- [PICS/SHEET]** Selects the number of pictures per sheet. Displayed when you have selected [MULTI PRINT].

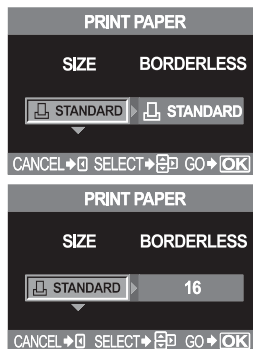





## Selecting pictures you want to print

Select pictures you want to print. The selected pictures can be printed later (single-frame reservation) or the picture you are displaying can be printed right away.

- PRINT (  )** Prints the currently displayed picture. If there is a picture that SINGLE PRINT reservation has already been applied to, only the picture with SINGLE PRINT reservation will be printed.



- SINGLE PRINT (  )** Applies print reservation to the currently displayed picture. If you want to apply reservation to other pictures, press  to select them.

- MORE (  )** Sets the number of prints and other items for the currently displayed picture, and whether or not to print it.
-  "Setting printing data" (P. 150)

## Setting printing data

Select whether to print printing data such as the date and time or file name on the picture when printing.

[

Sets the number of prints.

[

Prints the date and time recorded on the picture.

[FILE NAME]

Prints the file name recorded on the picture.

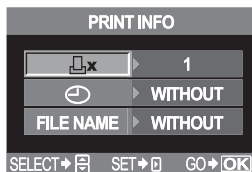

## Printing

Print when you have set the pictures for printing and printing data.

[OK]

Transfers images you print to the printer.

[CANCEL]

Resets the settings. All print reservation data will be lost. If you want to keep the print reservation data and make other settings, press . This returns you to the previous setting.



To stop and cancel printing, press the  button.

[CONTINUE]

Continues printing.

[CANCEL]

Cancels printing. All print reservation data will be lost.

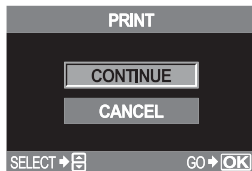







## If an error code is displayed

If an error code is displayed during direct printing setting or printing, see the following table.

For more details on solutions, refer to the printer's instruction manual.

If other codes are displayed, refer to "Error codes" (P. 168).

Monitor indication	Possible cause	Corrective action
 NO CONNECTION	The camera is not connected to the printer correctly.	Disconnect the camera and connect it again correctly.
 NO PAPER	There is no paper in the printer.	Load some paper in the printer.
 NO INK	The printer has run out of ink.	Replace the ink cartridge in the printer.
 JAMMED	The paper is jammed.	Remove the jammed paper.
SETTINGS CHANGED	The printer's paper cassette has been removed or the printer has been manipulated while making settings on the camera.	Do not manipulate the printer while making settings on the camera.
 PRINT ERROR	There is a problem with the printer and/or camera.	Turn off camera and printer. Check the printer and remedy any problems before turning the power on again.
 CANNOT PRINT	Pictures recorded on other cameras may not be printed on this camera.	Use a personal computer to print.

# 10

## Transferring images to a computer

Transferring images to your computer is a great way to make the most of the potential of digital imaging. Not only can you print the images of your choice, you can also use image processing software to organize, edit, and manipulate images. There are so many things you can do. Sort images by date/ time or other criteria. Trim, crop, colorize, or add special effects. And much more.

Once you've transferred images to your computer, you can email them to friends, post them on your website, create slideshows or HTML albums, you can even use them as wallpaper for your desktop.

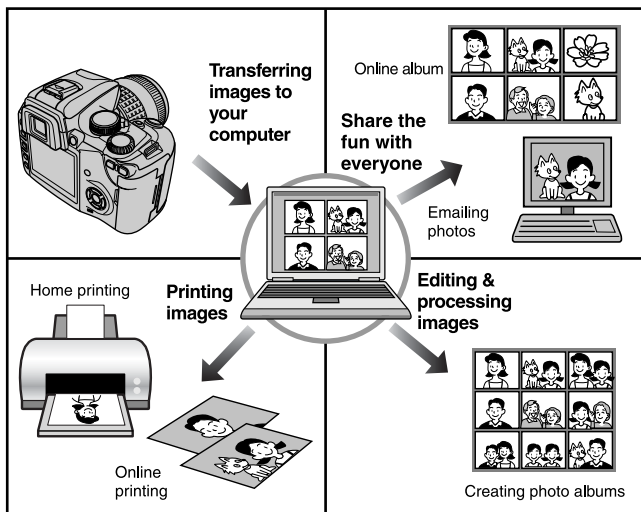

## Flowchart

Just connect the camera to a computer with the USB cable and you can easily transfer images stored on the card to the computer with the provided OLYMPUS Master software.

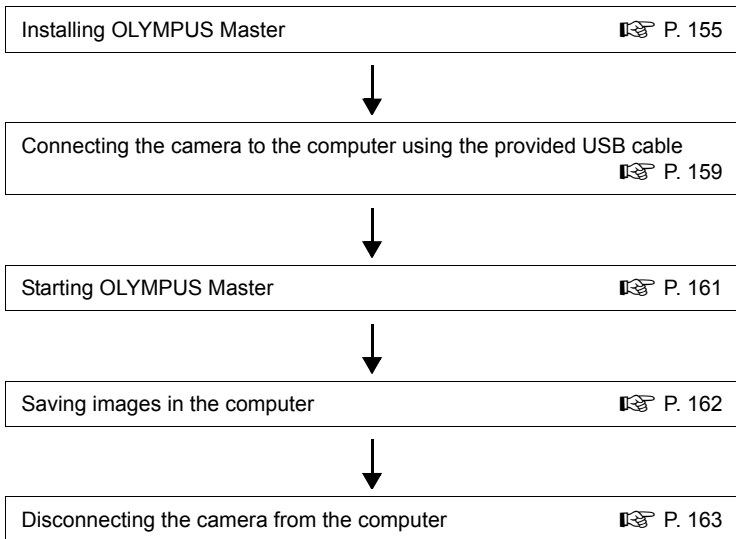

### Notes

- Keep an eye on the battery remaining power. If battery power runs low, the camera may stop operating while connected to the computer. This could cause the computer to malfunction, and any image data (file) being transmitted may be lost.
- Never open the camera's battery/card compartment cover while the card access lamp is blinking. Doing so may destroy the image files.
- If the camera is connected to the computer via a USB hub, operation may not be stable if there are any compatibility problems between the computer and the hub. In such cases, do not use the hub and connect the camera directly to the computer instead.
- If you want to process images using graphics applications, be sure to download them to your computer first. Depending on the software, image files may be destroyed if the images are processed (rotated, etc.) while they are on the card.
- If your computer cannot read the camera's image data via the USB connection, you can use an optional PC card adapter or other media adapter to transfer images from a CompactFlash or xD-Picture Card to the computer.  
For details, see the Olympus web site.

## Using the provided OLYMPUS Master software

Install the OLYMPUS Master software from the provided CD-ROM to edit and manage images on your computer.

### What is OLYMPUS Master?

OLYMPUS Master is an image management program with viewing and editing features for pictures taken with your digital camera. Once installed on your computer, you can take advantage of the following.

#### Viewing images and movies

You can also enjoy slideshows and sound playback.

#### Grouping and organizing images

You can organize images by displaying them in a calendar format. Using shooting date or key words, you can quickly find the particular images you want.

#### Transferring images from the camera or removable media to your computer

#### Editing images

You can rotate, trim or change the image size.

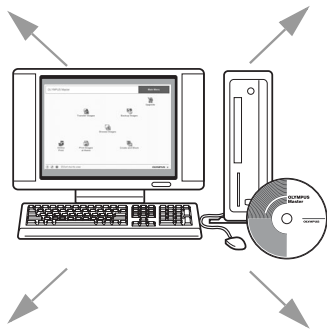

#### Correcting images using filter and correction functions

#### A variety of printing formats

You can print in a variety of formats including index prints, calendars, postcards, and more.

#### Creating panorama images

You can make a panorama from the photos you have taken using the panorama function.

For information about OLYMPUS Master's other features, as well as for details on how to use the software, refer to OLYMPUS Master Help or the OLYMPUS Master software user's guide.

## Installing OLYMPUS Master

Identify the OS on your computer before installing the software. For the latest information on compatible operating systems, visit the OLYMPUS web site (<http://www.olympus.com>).

### System requirements

#### ■ Windows

<b>OS</b>	Windows 98SE/Me/2000 Professional/XP
<b>CPU</b>	Pentium III 500 MHz or higher
<b>RAM</b>	128 MB or more (256 MB or more recommended)
<b>HD space</b>	300 MB or more
<b>Interface</b>	USB port
<b>Monitor</b>	1024 x 768 pixel or more, minimum 65,536 colors

#### ! Notes

- Only pre-installed operating systems are supported.
- To install OLYMPUS Master on a computer running Windows 2000 Professional or Windows XP, login as a user with administrator privileges.
- QuickTime 6 and Internet Explorer or later must be installed on the computer beforehand.
- For Windows XP, Windows XP Professional/Home Edition is supported.
- For Windows 2000, only Windows 2000 Professional is supported.
- For Windows 98SE, a USB driver will be automatically installed.

#### ■ Macintosh

<b>OS</b>	Mac OS X 10.2 or later
<b>CPU</b>	Power PC G3 500 MHz or higher
<b>RAM</b>	128 MB or more (256 MB or more recommended)
<b>HD space</b>	300 MB or more
<b>Interface</b>	USB port
<b>Monitor</b>	1024 x 768 pixel or more, minimum 32,000 colors

#### ! Notes

- If your Macintosh has no built-in USB port, its functionality may not be guaranteed when the camera is connected to the computer via USB.
- QuickTime 6 or later and Safari 1.0 or later must be installed on your computer.
- Be sure to remove the card (drag and drop it onto the Trash icon) first before performing the following procedures. If you skip these procedures, the computer may not function properly, requiring you to restart it.
  - Unplug the cable connected between the camera and computer.
  - Turn off the camera.
  - Open the camera's card compartment cover.

## How to install

### ■ Windows

#### 1 Boot your computer and insert the OLYMPUS Master CD into your CD-ROM drive.

- The OLYMPUS Master Setup Menu will automatically launch.
- If the menu window does not appear, double-click the [My Computer] icon, and click the CD-ROM icon.

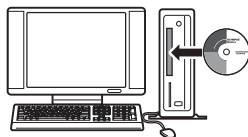

#### 2 Click the [OLYMPUS Master] button.

- The QuickTime Setup program will automatically run.
- QuickTime is required to run OLYMPUS Master. If QuickTime 6 or later is preinstalled on your computer, the setup program will not run. In this case, go to step 4.



#### 3 Click the [Next] button, then follow the on-screen prompts to continue installing the program.

- When the software license agreement window appears, read the license agreement text, then click [Agree].
- The OLYMPUS Master installation window appears.

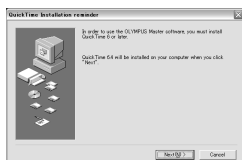

#### 4 Follow the on-screen prompts to continue installing the program.

- When the software license agreement window appears, read the license agreement text, then click [Yes].

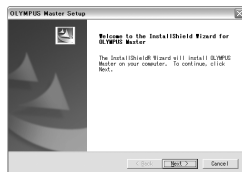



- When a dialog box prompting you for User Information appears, enter your name and the OLYMPUS Master serial number that is printed on the label on the CD-ROM package. Select your region, then click [Next].

Installation starts. When the DirectX license agreement window appears, read the message, then click [Yes] to continue installation.

- A confirmation window appears, asking you if you want to install Adobe Reader. To view the OLYMPUS Master software user's guide, Adobe Reader must be installed. If Acrobat Reader is preinstalled on your computer, the confirmation window will not appear.

## 5 If you want to install Adobe Reader, click [OK].

- If you do not want to install the program, click [Cancel]. Go to step 7.
- The Adobe Reader installation window appears.

## 6 Follow the on-screen prompts to continue installing the program.

- A window appears to inform you when installation is complete.

## 7 Click [Finish].

- The screen returns to the Olympus Software Setup Menu.

## 8 Select the option to restart immediately when the screen asking you if you wish to restart the computer is displayed and click [OK].

- The computer restarts.

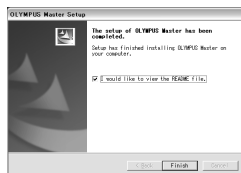
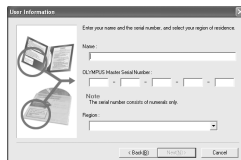

## ■ Macintosh

### 1 Insert the OLYMPUS Master software CD into your CD-ROM drive.

- The CD-ROM window automatically appears.
- If the screen does not appear, double-click the CD-ROM icon on your desktop.



### 2 Double-click on the desired language folder.

### 3 Double-click the [Installer] icon.

- Follow the on-screen prompts to continue installing the program. OLYMPUS Master Installer will automatically launch.
- When the software license agreement window appears, read the license agreement text, then click [Continue] and [Agree].
- A window appears to inform you when installation is complete.



### 4 Click the [Quit] button.

### 5 Remove the CD, then click [Restart].

# Connecting the camera to a computer

Connect the camera to your computer with the provided USB cable.

**1** Insert the marked end of the provided USB cable into the USB port on your computer.

- The location of the USB port varies depending on the computer. For details, refer to your computer's manual.

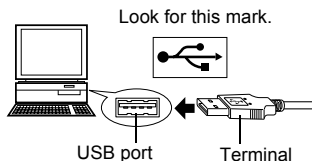

**2** Insert the provided USB cable into the multi-connector.

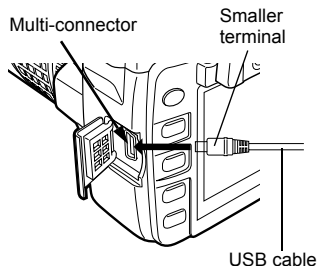

**3** Set the camera's power switch to ON.

- The selection screen for the USB connection is displayed.

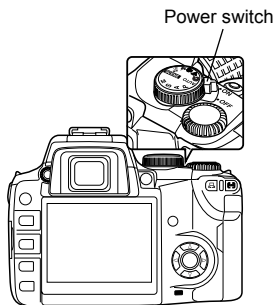

**4** Use   to select [STORAGE]. Press the  button.

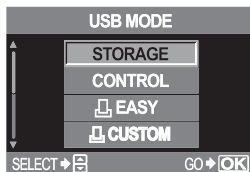

## 5 The computer recognizes the camera as a new device.

### • Windows

When you connect the camera to the computer for the first time, the computer automatically recognizes the camera.

Click [OK] when the message saying that the installation is completed appears.

The computer recognizes the camera as a [Removable Disk ].

### • Macintosh

iPhoto is the default image management application for Mac OS. When you connect your Olympus digital camera for the first time, iPhoto will start up automatically. Close iPhoto and start OLYMPUS Master.

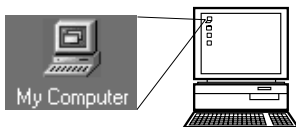

Removable  
Disk (F:)

### Notes

- When the camera is connected to the computer, none of the camera buttons are functional.

# Starting OLYMPUS Master

## ■ Windows

### 1 Double-click (OLYMPUS Master) on the desktop.

- The OLYMPUS Master main menu appears.

## ■ Macintosh

### 1 Double-click (OLYMPUS Master) in the [OLYMPUS Master] folder.

- The OLYMPUS Master main menu appears.
- The first time you start the program, a dialog box appears, prompting you for User Information. Enter your name and the OLYMPUS Master serial number that is printed on the affixed label, then select your region.

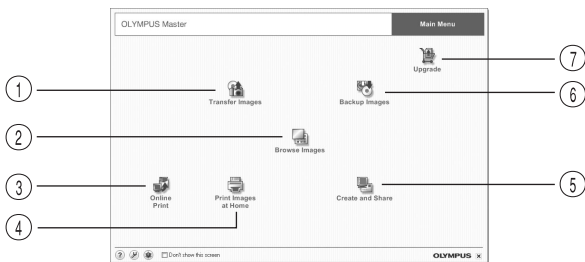

- |  |   |
|--|---|
| <p>① <b>[Transfer Images] button</b><br/>Transfers images from the camera or removable media.</p> <p>② <b>[Browse imaged] button</b><br/>Displays the Browse window.</p> <p>③ <b>[Online Print] button</b><br/>Display the online print window.</p> <p>④ <b>[Print Images at Home] button</b><br/>Displays the print menu.</p> | <p>⑤ <b>[Create and Share] button</b><br/>Displays menus to enjoy images.</p> <p>⑥ <b>[Backup Images] button</b><br/>Backs up images onto removable media.</p> <p>⑦ <b>[Upgrade] button</b><br/>Displays the dialog box that allows upgrade to OLYMPUS Master Plus.</p> |
|--|---|

## Closing OLYMPUS Master

### 1 Click (Exit) in the main menu.

- The OLYMPUS Master program is closed.

## Downloading images to save on your computer

Save images downloaded from the camera on your computer.

- 1 Click  (Transfer Images) in the OLYMPUS Master main menu.
  - The selection menu for the folders containing the files to be copied appears.

- 2 Click  (From Camera).
  - The window containing the files to be copied appears. The thumbnails of all the images in the camera appear.

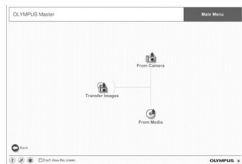

- 3 Select the image file you want to save on the computer, then click the [Transfer Images] button.
  - A confirmation message appears.

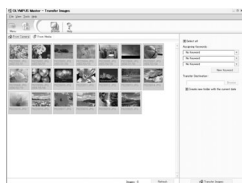

- 4 Click the [Browse images now.] button.
  - The images downloaded to the Browse window appear.
  - Clicking [Menu] in the Browse window returns to the main menu.
  - Never open the camera's battery/card compartment cover while the card access lamp is blinking. Doing so may destroy the image files.



## Disconnecting the camera from your computer

After downloading images from the camera to your computer, you can disconnect the camera from your computer.

- 1 Make sure that the card access lamp has stopped blinking.
- 2 Do the following steps depending on your computer's operating system.

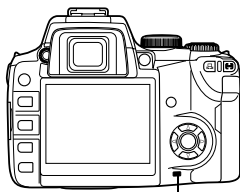

Card access lamp

### Windows 98SE

- 1) Double-click the [My Computer] icon and right-click the [Removable Disk] to display the menu.
- 2) Click [Eject] on the menu.



### Windows Me/2000/XP

- 1) In the System Tray, click the Remove Hardware icon .
- 2) Click on the pop-up message.
- 3) Click [OK] on the [Safe to Remove Hardware] window.



**Macintosh**

- 1) The trash icon changes to the eject icon when the “Untitled” or “NO\_NAME” icon on the desktop is dragged. Drag and drop it on the eject icon.



- 3 Unplug the USB cable from the camera.

**! Notes**

- **For Windows Me/2000/XP users:**  
When you click [Unplug or Eject Hardware], a warning message may be displayed. In such case, make sure that no image data is being downloaded from the camera, and that there are no applications open that were accessing the camera image files. Close any such applications and click [Unplug or Eject Hardware] again and then remove the cable.

**Viewing still images**

- 1 Click  (Browse Images) in the OLYMPUS main menu.
  - The Browse window appears.
- 2 Double-click the thumbnail of the image you want to view.

Thumbnail

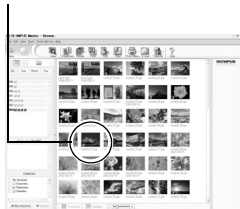

- The screen switches to the View mode, enlarging the image.
- Clicking the [Menu] in the Browse window returns to the main menu.

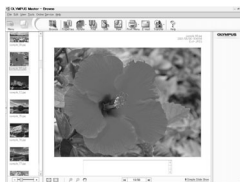



# Printing images

The print menus include menus such as [Photo], [Index], [Postcard], [Calendar] etc. The examples in the instructions below are taken from the [Photo] menu.

**1** Click  (**Print Images at Home**) in the **OLYMPUS Master** main menu.

- The print menu appears.

**2** Click  (**Photo**).

- The photo print window appears.



**3** Click  (**Settings**) on the photo print window.

- The printer setting dialog box appears. Make printer settings as required.

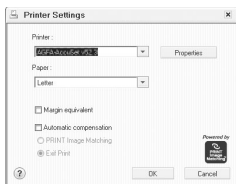

**4** Select the layout and size of the image to print.

- To print images with the date or date and time, check off [Print Date], then select [Date] or [Date & Time].

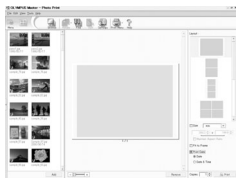

**5** Select the thumbnail of the image you want to print, then click the [Add] button.

- The selected image is previewed on the layout.

**6** Set the number of images to print.

**7** Click the [Print] button.

- Clicking [Menu] in the photo print window returns to the main menu.

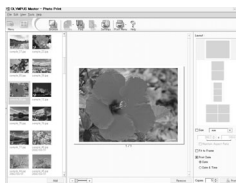

## Transferring images to your computer without using OLYMPUS Master

Your camera supports the USB Mass Storage Class. You can transfer images to a computer by connecting the camera to the computer with the provided USB cable.

This can be done even without using OLYMPUS Master.

The following operating systems are compatible with the USB connection:

**Windows** : Windows 98SE/Me/2000 Professional/XP

**Macintosh** : Mac OS 9.0-9.2/X

### ! Notes

- Users running Windows 98SE need to install the USB driver. Before connecting the camera to your computer with the USB cable, double-click the file included in the following folder on the provided OLYMPUS Master CD-ROM. When you install OLYMPUS Master, the USB driver will be installed at the same time.  
Your computer's drive name: \USB\INSTALL.EXE
- Even if your computer has a USB connector, data transfer may not function correctly if you are using one of the operating systems listed below or if you have an add-on USB connector (extension card, etc.).
  - Windows 95/98/NT 4.0
  - Windows 98SE upgrade from Windows 95/98
  - Mac OS 8.6 or lower
  - Data transfer is not guaranteed on a home-built PC system or PCs with no factory installed OS.

# 11

## Appendix

The appendix will assist in solving most problems you may encounter.



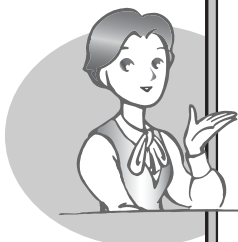







Solutions to error messages, operational problems, blurry pictures, camera storage, basic terminology and more can easily be found in this section.



### If you encounter problems

Error codes  
Troubleshooting  
Camera maintenance  
Safety precautions

## Error codes

Viewfinder indications	Monitor indications	Possible cause	Corrective action
Normal indication	 NO CARD	The card is not inserted, or it cannot be recognized.	Insert a card or insert a different card.
	 CARD ERROR	There is a problem with the card.	Insert the card again. If the problem persists, format the card. If the card cannot be formatted, it cannot be used.
	 WRITE PROTECT	Writing to the card is prohibited.	The card has been set to read-only setting with the computer. Reset the card with the computer.
No indication	 CARD FULL	The card is full. No more pictures can be taken or no more information such as print reservation can be recorded.	Replace the card or erase unwanted pictures. Before erasing, download important images to a PC.
No indication	 NO PICTURE	There are no pictures on the card.	The card contains no pictures. Record pictures.
No indication	 PICTURE ERROR	The selected picture cannot be displayed for playback due to a problem with this picture. Or the picture cannot be used for playback on this camera.	Use image processing software to view the picture on a PC. If that cannot be done, the image file is damaged.
	 CARD-COVER OPEN	The card cover is open.	Close the card cover.

Viewfinder indications	Monitor indications	Possible cause	Corrective action
	CARD ERROR	The card is not formatted.	Format the card.
No indication	BATTERY EMPTY	The battery is drained.	Charge the battery.

## Troubleshooting

Possible cause	Corrective action	Ref. Page
<b>The camera does not turn on or function buttons do not respond.</b>		
The power is off.	The camera automatically turns off if it is not operated for a certain period of time. Set the power switch to ON.	–
The camera enters the sleep mode.	Press the shutter button halfway.	P. 133
The battery is drained.	Charge the rechargeable battery. When you use lithium batteries, replace with new ones.	–
The battery is temporarily unable to function because of the cold.	Warm the battery by putting it in your pocket for a while.	–
The camera is connected to a PC.	The camera will not operate while it is connected to a PC. The optional OLYMPUS Studio software is required in the [CONTROL] mode.	P. 134

Possible cause	Corrective action	Ref. Page
<b>No picture is taken when the shutter button is pressed.</b>		
The battery is drained.	Charge the rechargeable battery. When you use lithium batteries, replace with new ones.	–
Subjects are difficult to focus on (AF does not work properly).	Use manual focus or focus lock to focus on the subject and then shoot.	P. 27 P. 73
Pictures are being recorded to the card.	During sequential shooting, no pictures can be taken when the camera's memory is full.	–
The flash has not finished charging.	Remove your finger from the shutter button, and wait until the ⚡ mark stops blinking. Press the shutter button again.	P. 55
The card is full.	Erase unwanted images or insert a new card. Before erasing, download important images to a PC.	P. 115 P. 162
The battery ran out of power during shooting or while the images were being written to the card. (The monitor turns off after "BATTERY EMPTY" is displayed.)	Charge the battery. (Wait until the card access lamp stops blinking.)	–
There is a problem with the card.	Refer to the error messages.	P. 168
<b>The viewfinder display is not clear.</b>		
The diopter is not adjusted.	Adjust the diopter so that the AF frame is clearly visible.	–
There is condensation* in the lens or viewfinder.	Turn off the camera's power and wait until the camera is dry. The camera will dry out as it gets accustomed to the environmental temperature.	–
<b>The date recorded with the image data is wrong.</b>		
The date/time is not set.	Set the date/time. The clock adjustment is not factory-preset.	P. 138
The camera was left for a long period with the battery removed.	If the camera is left for a long period with the battery removed, the stored date/time setting will be canceled. Set the date/time again.	P. 138

\* Condensation: When it is cold outside, the water vapor in the air is rapidly cooled and turns to droplets of water. Condensation occurs when the camera is suddenly taken from a cold place into a warm room.

Possible cause	Corrective action	Ref. Page
<b>Turning the camera's power off does not reset the stored settings.</b>		
This camera retains the saved settings after the camera's power is turned off.	Turning the camera's power off does not reset the saved settings. Set [CUSTOM RESET SETTING] to [RESET], then turn off the camera.	P. 118
<b>The picture is out of focus.</b>		
The subject is too close.	Move back to the closest focusing distance for the lens and take the picture.	–
Subjects are difficult to focus on (AF does not work properly).	Use manual focus or focus lock to focus on the subject and then shoot.	P. 27 P. 73
The subject is dark.	Set [AF ILLUMINATOR] to [ON] in the menu and raise the flash.	P. 75
There is condensation* in the lens or viewfinder.	Turn off the camera's power and wait until the camera is dry.	–
<b>The picture is blurred.</b>		
A subject unsuited to AF was taken.	Use manual focus or focus lock to focus on the subject and then shoot.	P. 27 P. 73
The camera moved when the shutter button was pressed.	Camera vibrations will result in a blurred picture. Hold the camera correctly and press the shutter button gently. When a telephoto lens is used, special care is needed.	–
ISO is set to auto in a dark environment.	The camera is more likely to move with slower shutter speeds. Use the flash or set a higher ISO sensitivity. The use of a tripod is also recommended.	P. 50 P. 82
[RELEASE PRIORITY S] or [RELEASE PRIORITY C] is set to [ON].	The [RELEASE PRIORITY S] & [RELEASE PRIORITY C] functions on this camera allow you to release the shutter at exactly the right moment. However, when [RELEASE PRIORITY S] or [RELEASE PRIORITY C] is set to [ON], the shutter will be released even if the subject is not in focus. Make sure that [RELEASE PRIORITY S] or [RELEASE PRIORITY C] is set to [OFF] or the AF confirmation mark lights on the viewfinder before pressing the button all the way.	P. 75
The lens was dirty.	Clean the lens. Use a commercially available blower brush and then wipe with a lens cleaner to remove dust. Mold may form on the lens surface if the lens is left dirty.	P. 174

Possible cause	Corrective action	Ref. Page
<b>The picture is too bright.</b>		
There was something dark in the center of the image.	When there is something dark in the center of the image, the edges of the image will be brighter regardless of the metering system. Adjust the exposure toward minus (-).	P. 79
The ISO setting is high.	Set ISO to auto or 100. If there is no improvement, use a commercially available ND filter compatible with the lens.	P. 82
A low aperture value is set in the A (M) mode.	Increase the aperture value.	P. 41, P. 45
A slow shutter speed is set in the S (M) mode.	Increase the shutter speed.	P. 43, P. 45
<b>The picture is too dark.</b>		
The subject was too small and was backlit.	Set the metering system to spot metering. Or use the flash.	P. 50 P. 77
There was something bright in the center of the image.	When there is something bright in the center of the image, the whole image will be darker regardless of the metering system. Adjust the exposure toward plus (+).	P. 79
A high aperture value is set in the A (M) mode.	Decrease the aperture value.	P. 41, P. 45
A fast shutter speed is set in the S (M) mode.	Reduce the shutter speed.	P. 43, P. 45
<b>The colors of pictures taken indoors look unnatural.</b>		
Indoor lighting affected the picture's colors.	Set the appropriate white balance for the lighting. More natural-looking colors can be reproduced with the one-touch white balance.	P. 90
The white balance setting is wrong.	Set the appropriate white balance for the lighting again.	P. 87
<b>Halation produces unnatural colors in the picture.</b>		
This may be caused by excessively bright ultraviolet light on the subject, such as sunlight shining through the leaves of trees, brightly lit windows at night, reflections off metal in direct sunlight, etc.	<ul style="list-style-type: none"> <li>• Use a commercially available UV filter. As this may upset the overall color balance, it should only be used under the conditions described on the left.</li> <li>• Process the picture using a graphics application that supports JPEG (Paint Shop Pro, Photoshop, etc.). For example, after picking up unnatural colors with an eyedropper tool, etc., you can select color areas, and try color conversion or saturation adjustment. For details, refer to the manual for the graphics application you are using.</li> </ul>	—



Possible cause	Corrective action	Ref. Page
<b>The top left part of the picture appears too bright.</b>		
When shooting at slow shutter speeds, noise may be generated due to a rise in temperature in the CCD drive circuit.	Set [NOISE REDUCTION] to [ON] before taking pictures.	P. 95
<b>Pictures cannot be played back on the monitor.</b>		
Pictures are not stored on the card.	"NO PICTURE" appears on the monitor. Record pictures.	–
The card error occurs.	Refer to the error messages.	P. 168
<b>No picture is displayed on the TV when connected to the camera.</b>		
The video cable is not connected correctly.	Connect the cable properly according to the instructions.	P. 108
The camera's video output signal is incorrect.	Set the video signal according to the region where used.	P. 135
The TV 's video signal is incorrect.	Set the TV to the video input mode.	–
<b>The monitor is hard to see.</b>		
The brightness is not adjusted properly.	Adjust the brightness of the monitor using the menu.	P. 133
The monitor is exposed to direct sunlight.	Block the sunlight with your hand.	–
<b>The computer does not recognize the camera correctly.</b>		
The camera's power is turned off.	Set the power switch to ON.	–
The USB driver was not successfully installed.	Install the OLYMPUS Master.	P. 155
The camera is in the [CONTROL] mode.	Set [USB MODE] to [AUTO] or [STORAGE]. When [AUTO] is set, the selection screen for USB connection is displayed every time you connect the USB cable to the camera.	P. 134

## Cleaning and storing the camera

### ■ Cleaning the camera

Turn off the camera and remove the battery before cleaning the camera.

#### Exterior:

→ Wipe gently with a soft cloth. If the camera is very dirty, soak the cloth in mild soapy water and wring well. Wipe the camera with the damp cloth and then dry it with a dry cloth. If you have used the camera at the beach, use a cloth soaked in clean water and well wrung.

#### Monitor and viewfinder:

→ Wipe gently with a soft cloth.

#### Lens, mirror and focusing screen:

→ Blow dust off the lens, mirror and focusing screen with a commercially available blower. For the lens, wipe gently with a lens cleaning paper. Do not use a high-pressure bottled blower. If high-pressure gas is sprayed onto the lens, mirror, or focusing screen by non-authorized service persons, the camera will be damaged.

### ■ Storage

- When storing the camera for extended periods, remove the battery and card. Store the camera in a cool, dry place that is well ventilated.
- Replace the battery periodically and test camera functions.

### Cleaning and Checking the CCD

This camera incorporates a dust reduction function to keep dust from getting on the CCD and to remove any dust or dirt from the CCD surface with ultrasonic vibrations. Dust reduction works when the power switch is set to ON.

Since dust reduction is activated every time the camera's power is turned on, the camera should be held upright for the dust reduction function to be effective. The SSWF indicator blinks while dust reduction is working.   
"Names of parts" (P. 190)

### Notes

- Do not use strong solvents such as benzene or alcohol, or chemically treated cloth.
- Avoid storing the camera in places where chemicals are treated, in order to protect the camera from corrosion.
- Mold may form on the lens surface if the lens is left dirty.
- Check each part of the camera before use if it has not been used for a long time. Before taking important pictures, be sure to take a test shot and check that the camera works properly.



## Cleaning mode — Removing dust on the CCD

If dust or dirt gets on the CCD, black dots may appear in the picture. If this happens, contact your Olympus Authorized Service Center to have the CCD physically cleaned. The CCD is a precision device and is easily damaged. When cleaning the CCD yourself, be sure to follow the instructions below. If a battery is used and power runs out during cleaning, the shutter will close, which may cause the shutter curtain and mirror to break.

**1** Remove the lens from the camera.

**2** Set the power switch to ON.

**3** Menu ▸ [i2] ▸ [CLEANING MODE]

**4** Press , then press the  button.

- The camera enters the cleaning mode.

**5** Press the shutter button fully.

- The mirror goes up and the shutter curtain opens.

**6** Clean the CCD.

- Carefully blow off any dust on the surface of the CCD by using a mechanical blower (commercially available).

**7** Be careful not to catch the mechanical blower in the shutter curtain when turning the power off to finish cleaning.

- If the camera turns off, the shutter curtain closes, causing the mirror to fall.

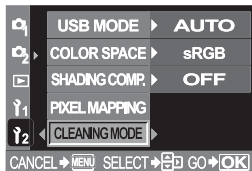

### Notes



- Be careful to not let the mechanical blower (commercially available) touch the CCD. If the blower touches the CCD, the CCD will be damaged.
- Never put the mechanical blower behind the lens mount. If the power turns off, the shutter closes, breaking the shutter curtain.
- Do not use anything other than the mechanical blower. If high-pressure gas is sprayed onto the CCD, it will freeze on the CCD's surface, damaging the CCD.

## Pixel mapping — Checking the image processing functions

The pixel mapping feature allows the camera to check and adjust the CCD and image processing functions. It is not necessary to operate this function frequently.

Approximately once a year is recommended. After using the monitor or taking continuous shots, wait for at least one minute before using the pixel mapping function to ensure that it operates correctly.

**1** Menu ▸ [i2] ▸ [PIXEL MAPPING]

**2** Press , then press the  button.

- The [BUSY] bar is displayed when pixel mapping is in progress. When pixel mapping is finished, the menu is restored.

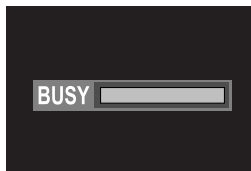
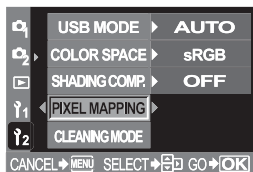

### Notes

- If you accidentally turn the camera off during pixel mapping, start again from Step 1.

### **A (Aperture Priority) Mode**

You set the aperture yourself and the camera automatically varies the shutter speed so that the picture is taken with the correct exposure.

### **AE (Automatic Exposure)**

The camera's built-in exposure meter automatically sets the exposure. The 3 AE modes available on this camera are P mode, in which the camera selects both the aperture and shutter speed, A mode, in which the user selects the aperture and the camera sets the shutter speed, and S mode, in which the user selects the shutter speed and the camera sets the aperture.

In M mode, the user selects both the aperture and the shutter speed.

### **Aperture**

The adjustable lens opening which controls the amount of light that enters the camera. The larger the aperture, the shorter the depth of field and the fuzzier the background. The smaller the aperture, the greater the depth of field and the sharper the background. Aperture is measured in f/stops. Larger aperture values indicate smaller apertures, and smaller aperture values indicate larger apertures.

### **AUTO mode**

Program AE mode (see "P (Program) Mode"). In addition, this mode features automatic flash pop up when shooting in low-light conditions.

### **CCD (Charge-Coupled Device)**

This converts light passing through the lens into electrical signals. On this camera, light is picked up and converted into RGB signals to build a single image.

### **Center weighted averaging metering**

A light metering mode or technique that uses an average of the center and periphery of the image area but is biased toward the information at the center of the image area. This method is best used when the brightness of the center and periphery of the image area does not vary greatly. See also digital ESP metering and spot metering.

### **Color space**

A model that describes colors using more than three coordinates. Color spaces such as sRGB, Adobe RGB are occasionally used for encoding/reproducing colors.

**Color temperature**

The spectral balance of different white light sources is rated numerically by color temperature — a concept of theoretical physics that, with incandescent lighting, corresponds roughly to the absolute lamp filament temperature, expressed on the Kelvin (K) temperature scale. The higher the color temperature, the richer the light in bluish tones and the poorer in reddish; the lower the color temperature, the richer the light in reddish tones and the poorer in bluish. You may encounter difficulties with color reproduction when shooting indoors under fluorescent lighting, or where sunlight and fluorescent lighting are both present. Your camera is provided with a white balance adjustment feature that you can use to compensate for the odd effects of combinations of color you may occasionally see in your pictures.

**Compression rate**

Compression is a method of reducing file size by abbreviating some contents of data, and compression rate denotes the amount of compression. The actual effect of the selected compression rate could vary with the content of the image. The numbers for the compression rate selected with this camera provide only a general scale for reference and are not precise measurements.

**Conventional Photograph**

This refers to recording images using silver halide (the method for recording images in conventional, non-digital photography). This system is in contrast to still video and digital photography.

**DCF (Design rule for Camera File system)**

A standard for image files by the Japan Electronics and Information Technology Industries Association (JEITA).

**Depth of Field**

Depth of Field refers to the distance from the nearest to the furthest point of perceived "sharp" focus in a picture.

**Digital ESP (Electro-Selective Pattern) Light Metering**

This determines the exposure by metering and calculating the light levels in the center and other areas of the image separately.

**DPOF (Digital Print Order Format)**

This is for saving desired print settings on digital cameras. By entering which images to print and the number of copies of each, the user can easily have the desired images printed by a printer or print lab that supports the DPOF format.

**Eclipsing (Vignetting)**

This refers to when an object obscures part of the field of view so that the whole subject is not photographed. Vignetting also refers to when the image seen through the viewfinder does not exactly match the image shot through the objective lens, so the photographed image includes objects not seen through the viewfinder. In addition, vignetting can occur when an incorrect lens hood is used, causing shadowing to appear in the corners of the image.

**EV (Exposure Value)**

A system for measuring exposure. EV0 is when the aperture is at F1 and the shutter speed is 1 second. The EV then increases by 1 each time the aperture increases by one F stop or the shutter speed increases by one increment. EV can also be used to indicate brightness and ISO settings.

**Exposure**

The amount of light used to capture an image. The exposure is determined by the length of time the shutter is open (shutter speed) and the amount of light that passes through the lens (aperture).

**ISO**

A method for indicating film speed by the International Organization for Standardization (ISO) (e.g. "ISO100"). Higher ISO values indicate greater sensitivity to light, so images can be exposed even in low-light conditions.

**JPEG (Joint Photographic Experts Group)**

A compression format for color still images. Photographs (images) shot using this camera are recorded onto the card in JPEG format when the Record mode is set to SHQ, HQ, SQ. By downloading these images to a personal computer, users can edit them using graphics application software or view the images using an Internet web browser.

**M (Manual) Mode**

The user sets both the aperture and shutter speed.

**NTSC (National Television Systems Committee) / PAL (Phase Alternating Line)**

Television formats. NTSC is mainly used in Japan, North America and Korea. PAL is mainly used in Europe and China.

**Number of Pixels (PIXEL COUNT)**

The number of dots (pixels) used to create an image denotes the image size. For instance, an image in 640 x 480 resolution is the same size as the computer screen if the monitor setting is also 640 x 480. If the monitor setting is 1024 x 768, the image only takes up part of the screen.

## **P (Program) Mode**

Also called Program AE mode. The camera automatically sets the best shutter speed and aperture for the shot.

## **PictBridge**

A standard that enables digital cameras and printers made by different manufacturers to be connected, and also allows pictures to be printed directly from the camera.

## **Pixels**

A pixel is the smallest unit (dot) used to make up an image. Clear large-sized printed images require millions of pixels.

## **RAW**

Refers to raw data, data which has not been enhanced with a camera option like white balance, sharpness, contrast, etc. This file format is for viewing and processing with our own software. You may not be able to open or process these files with other graphics software applications, and these files cannot be selected for DPOF printing. RAW files are assigned an orf file extension (\*.orf).

## **S (Shutter Priority) Mode**

Also called Shutter Priority AE mode. The user selects the shutter speed and the camera automatically varies the aperture so that the picture is taken with the best exposure.

## **Single-lens reflex camera**

A camera with a shooting lens working also as the viewfinder lens. The image of the subject enters through the lens, reflects off of the mirror and into the pentaprism, where focus is adjusted, then through the viewfinder lens. Pictures are taken by framing the composition and adjusting the focus in the viewfinder lens.

## **Sleep Mode**

A mode designed to save battery life. The camera automatically enters the sleep mode if you do not operate it for a certain time. To get out of the sleep mode, use any button on the camera (shutter button, menu button, etc.)



**Spot metering**

The meter reading is taken from a very small area around the center of the subject, defined by the spot metering area mark in the viewfinder. Spot metering is ideal for use in difficult light conditions, or when the important element of the picture (subject's face) is small. Use spot metering for backlit subjects, or sports and stage performers. See also digital ESP metering and center weighted averaging metering.

**TIFF (Tagged Image File Format)**

A format used for saving highly detailed black and white or color image data. TIFF image files can be handled by software programs for scanners and graphics applications. Non-compressed image data are stored in this format with this camera.

**TFT (Thin-Film Transistor) Color Monitor**

A color monitor constructed using thin-film technology.

**TTL phase-contrast detection system**

This is used to measure the distance to the subject. The camera determines if the image is focused by the detected phase contrast.

**TTL (Through-The-Lens) System**

To help adjust exposure, a light receptor built into the camera directly measures the light passing through the lens.

# 12 Information







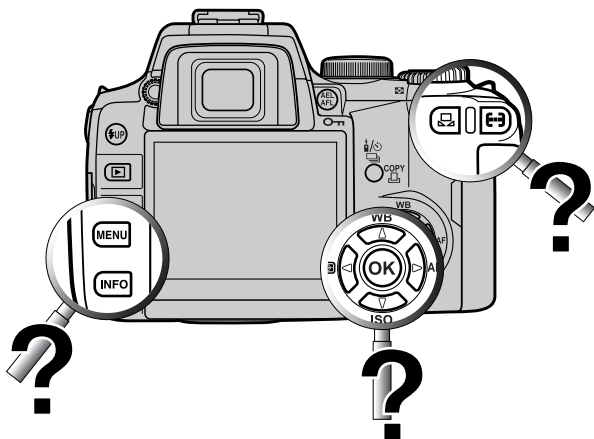











This chapter covers all the camera's functions already described in Chapters 1 through 11.

You can refer to the names of the camera's buttons and parts, the names and meanings of the icons displayed on the monitor, and the menu lists as necessary.

Use the index when you want to find the pages describing the functions and items if these are not included in the table of contents. You can also use the "Names of parts" and "Menu directory" to search for the relevant pages.



## Shooting Menu

Tab	Function	Setting	Ref. Page	
	CARD SETUP	ALL ERASE / FORMAT	P. 26 P. 115	
	CUSTOM RESET SETTING	RESET		P. 118
		RESET1	SET / RESET	
		RESET2	SET / RESET	
	PICTURE MODE	 VIVID* /  NATURAL /  MUTED / MONOTONE / SEPIA		P. 93
	GRADATION	HIGH KEY / NORMAL* / LOW KEY		P. 94
		HQ* / SQ / RAW+SHQ / RAW+HQ / RAW+SQ / RAW / TIFF / SHQ		P. 30
		-5.0 - 0.0* - +5.0		P. 79
	NOISE REDUCTION	OFF* / ON		P. 95
	WB	AUTO*	B7 - ±0 - R7 G7 - ±0 - M7	P. 87
		 5300K	B7 - ±0 - R7 G7 - ±0 - M7	
		 6000K	B7 - ±0 - R7 G7 - ±0 - M7	
		 7500K	B7 - ±0 - R7 G7 - ±0 - M7	
		 3000K	B7 - ±0 - R7 G7 - ±0 - M7	
		 4000K	B7 - ±0 - R7 G7 - ±0 - M7	
 4500K		B7 - ±0 - R7 G7 - ±0 - M7		
 6600K		B7 - ±0 - R7 G7 - ±0 - M7		
		B7 - ±0 - R7 G7 - ±0 - M7		
CWB		2000K - 14000K		
ISO		AUTO* / 100 - 1600		
METERING	 *	ESP+AF / ESP	P. 77	
				
				
	 HI			
	 SH			

\* Factory default setting

Tab	Function	Setting	Ref. Page
	FLASH MODE	P / A /  /  /  /  /  / : AUTO* /  /  /  /  SLOW /  SLOW / SLOW2 /  FULL /  1/4 /  1/16 /  1/64	P. 54
		S / M : * /  /  /  /  SLOW2 /  FULL / 1/4 /  1/16 /  1/64	
		-2.0 - 0.0* - +2.0	P. 56
		* /	P. 62
		12S /  2S	P. 63
	AF MODE	0S /  2S	P. 65
		S-AF* / C-AF / MF / S-AF+MF / C-AF+MF	P. 70
		AUTO* / [ ] / [ ] / [ ]	P. 69
	AE BKT	OFF* / 3F 0.3EV / 3F 0.7EV / 3F 1.0EV	P. 83
	WB BKT	R-B	OFF* / 3F 2STEP / 3F 4STEP /
G-M		3F 6STEP	
FL BKT	OFF* / 3F 0.3EV / 3F 0.7EV / 3F 1.0EV	P. 57	
MF BKT	OFF* / 5F 1STEP / 5F 2STEP / 7F 1STEP / 7F 2STEP	P. 74	
ANTI-SHOCK	OFF* / 1 - 30 SEC	P. 96	











\*Factory default setting

## Playback menu

Tab	Function	Setting	Ref. Page	
		1* /  4 /  9 /  16 /  25	P. 106	
		OFF / ON*	P. 107	
	EDIT	RAW DATA EDIT	BLACK & WHITE / SEPIA / REDEYE FIX / SATURATION / 	P. 109
		JPEG/TIFF EDIT		
		/	P. 142	
COPY ALL	YES / NO	P. 113		







\*Factory default setting

## Custom menu

Tab	Function	Setting	Ref. Page	
11	ISO STEP	1/3EV* / 1EV	P. 124	
	ISO BOOST	OFF* / ON+NF / ON	P. 124	
	ISO LIMIT	OFF* / 100 / 200 / 400 / 800	P. 124	
	EV STEP	1/3EV* / 1/2EV / 1EV	P. 123	
	ALL 	ALL SET	B7 - ±0* - R7	P. 125
			G7 - ±0* - M7	
		ALL RESET	YES / NO	
	HQ	1/4 / 1/8* / 1/12	P. 30	
	SQ	PIXEL COUNT	3200×2400 / 2560×1920 / 1600×1200 / 1280×960* / 1024×768 / 640×480	P. 30
			COMPRESSION	
	MANUAL FLASH	OFF* / ON	P. 125	
	 + 	OFF* / ON	P. 56	
	 X-SYNC	1/60 - 1/180	P. 126	
	AUTO POPUP	OFF / ON*	P. 126	
	DIAL	P	Ps* / 	P. 127
		M	SHUTTER* / FNo.	
	AEL/AFL	S-AF	mode1* - mode3	P. 121
		C-AF	mode1* - mode4	
		MF	mode1* - mode3	
	AEL/AFL MEMO	ON / OFF*	P. 123	
	AEL METERING	AUTO* /  /  /  HI /  SH	P. 123	
QUICK ERASE	OFF* / ON	P. 130		
RAW+JPEG ERASE	JPEG / RAW / RAW+JPEG*	P. 130		
 FUNCTION	 / TEST PICTURE / MY MODE / PREVIEW	P. 128		
MY MODE SETUP	NO DATA / MY MODE1 / MY MODE2	P. 128		
FOCUS RING	↺* / ↻	P. 129		
AF ILLUMINATOR	OFF / ON*	P. 75		
RESET LENS	OFF / ON*	P. 129		
RELEASE PRIORITY S	OFF* / ON	P. 75		
RELEASE PRIORITY C	OFF / ON*	P. 75		

\*Factory default setting

## Setup menu

Tab	Function	Setting	Ref. Page	
12			P. 138	
	CF/xD	CF / xD	P. 26	
	FILE NAME	AUTO* / RESET	P. 131	
	EDIT FILENAME	sRGB	OFF* / A-Z / 0-9	P. 132
		AdobeRGB		
		Lo -7 - 0* - Hi +7	P. 133	
		*1	P. 135	
	VIDEO OUT	NTSC / PAL*1	P. 135	
		OFF / ON*	P. 133	
	REC VIEW	OFF* / 1 SEC - 20 SEC	P. 132	
	SLEEP	OFF / 1 MIN* / 3 MIN / 5 MIN / 10 MIN	P. 133	
	4h TIMER	OFF / 4h*	P. 136	
	BUTTON TIMER	HOLD / 3 SEC* / 5 SEC	P. 136	
	SCREEN	OFF* / ON	P. 137	
	CTL PANEL COLOR	COLOR1* / COLOR2	P. 137	
	PRIORITY SET	YES / NO*	P. 129	
	USB MODE	AUTO* / STORAGE / CONTROL /  EASY /  CUSTOM	P. 134	
	COLOR SPACE	sRGB* / AdobeRGB	P. 96	
	SHADING COMP.	OFF* / ON	P. 94	
	PIXEL MAPPING		P. 176	
CLEANING MODE		P. 175		
FIRMWARE		P. 137		

\* Factory default setting

\*1 Settings differ depending on the region where the camera is purchased.













# Available functions by shooting mode

Function		AUTO	P	A	S	M		SCENE
Aperture value		-	✓	✓	-	✓		-
Shutter speed		-	✓	-		✓		-
Bulb shooting		-		-		✓		-
		-		✓		-	✓	-
		✓				✓		✓ (Cannot be selected in  mode)
Flash shooting		✓				✓		-
Flash mode	AUTO	✓	✓		-		✓	-
		✓	✓		-		✓	-
	SLOW	✓	✓		-		✓	-
	SLOW	-	✓		-		✓	-
		✓	-		✓		-	-
	SLOW2	-				✓		-
		✓				✓		-
	✓				✓		-	
CUSTOM RESET SETTING		✓				✓		-
PICTURE MODE		✓				✓		-
GRADATION		✓				✓		-
NOISE REDUCTION		✓				✓		-
		✓					✓	-
		✓				✓		-
METERING		✓				✓		-
		✓				✓		-
		✓					✓	-
		✓					✓	-
AF mode		✓				✓		-
AF target mark		✓				✓		-
AE BKT		✓				✓		-
WB BKT		✓				✓		-
FL BKT		✓				✓		-
MF BKT		✓				✓		-
ANTI-SHOCK		✓				✓		-
ISO STEP		✓				✓		-
ISO BOOST		✓				✓		-

✓ : Available      - : Not available

12

Information

Function	AUTO	P	A	S	M		SCENE
ISO LIMIT	✓			✓			–
EV STEP	✓			✓			✓ (Cannot be selected in  mode)
ALL 	✓			✓			✓ (Cannot be selected in  mode)
HQ	✓			✓			–
SQ	✓			✓			–
MANUAL FLASH	✓			✓			–
 + 	✓			✓			–
 X-SYNC	✓			✓			–
AUTO POP UP	✓			✓			–
DIAL	✓			✓			–
AEL/AFL	✓			✓			–
AEL/AFL MEMO	✓			✓			–
AEL METERING						✓	
QUICK ERASE						✓	
RAW+JPEG ERASE						✓	
 FUNCTION						✓	
MY MODE SETUP						✓	
FOCUS RING						✓	
AF ILLUMINATOR						✓	
RELEASE PRIORITY S						✓	
RELEASE PRIORITY C						✓	
						✓	
CF / xD						✓	
FILE NAME						✓	
EDIT FILENAME						✓	
						✓	
						✓	
VIDEO OUT						✓	
						✓	
REC VIEW						✓	
SLEEP						✓	
4h TIMER						✓	
BUTTON TIMER						✓	
SCREEN						✓	

✓ : Available    – : Not available



Function	AUTO	P	A	S	M		SCENE
CTL PANEL COLOR						✓	
PRIORITY SET						✓	
USB MODE						✓	
COLOR SPACE						✓	
SHADING COMP.						✓	
PIXEL MAPPING						✓	
CLEANING MODE						✓	

✓ : Available      – : Not available

# Names of parts

## Camera

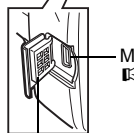
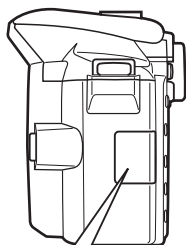
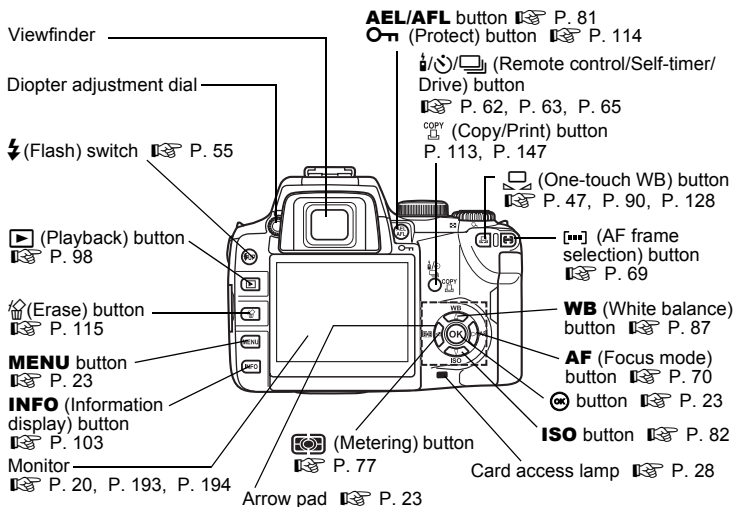

Connector cover

Multi-connector P. 146, P. 159

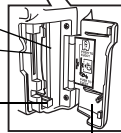

Card cover

CF card slot

xD card slot

Eject button

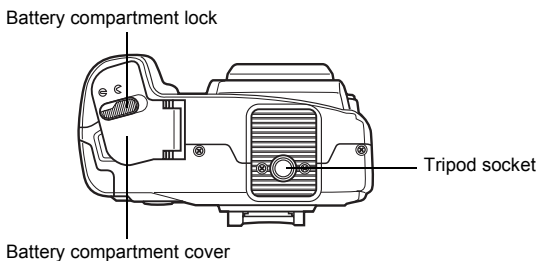
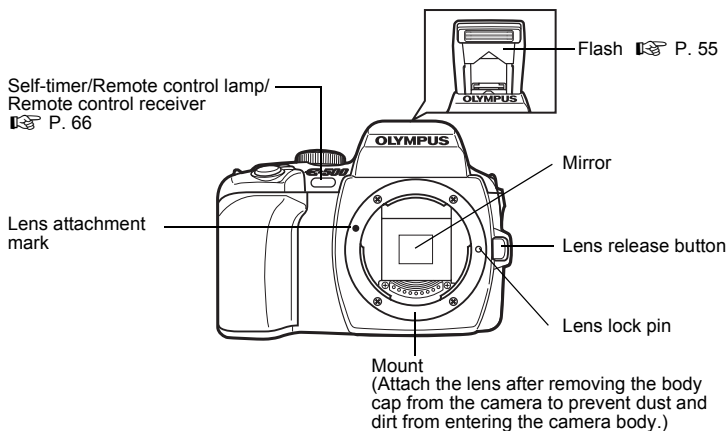
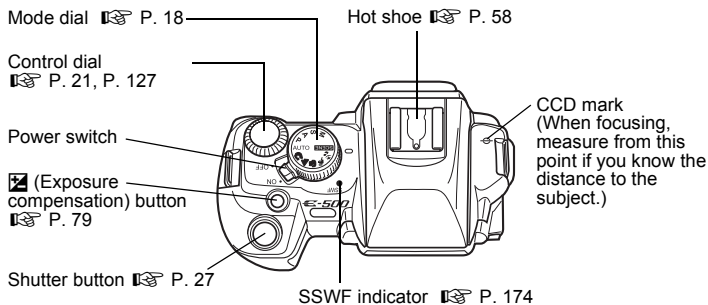

## Viewfinder indications

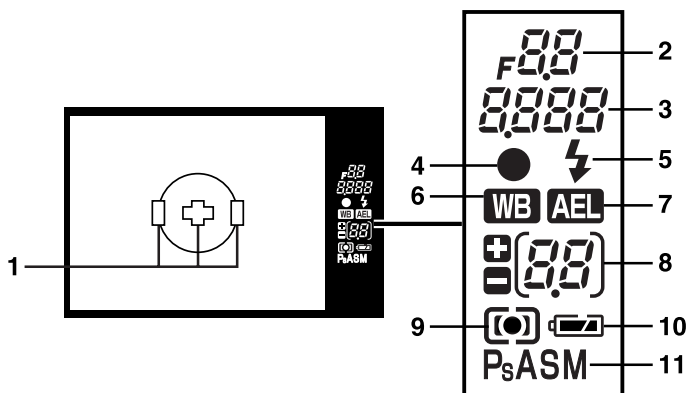

	Items	Indication examples	Ref. page
1	AF frame	□ ⊕ □	P. 69
2	Aperture value	<i>f</i> 5.6	P. 41 - 45
3	Shutter speed Record mode	250	P. 42 - 45
4	AF confirmation mark	●	P. 28
5	Flash	⚡	P. 55
6	White balance	WB	P. 87
7	AE lock	AEL	P. 81
8	Number of storable still pictures (appears during record mode setting) Exposure compensation value indication (appears during exposure compensation)	12 0.7	- P. 79
9	Metering mode	☰, ☉, ●	P. 77
10	Battery check	🔋 🔋 (blinks)	-
11	Exposure mode	P, Ps, A, S, M	P. 39 - 45





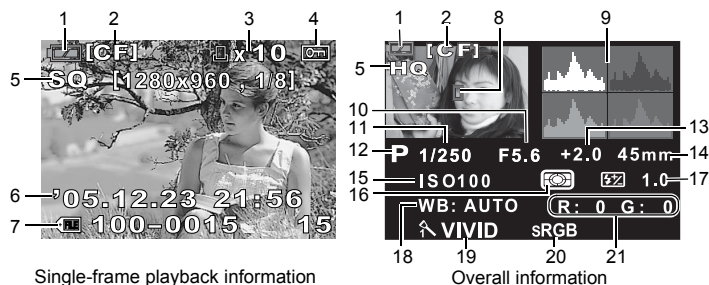













## Monitor indications (only for playback)

You can switch the monitor display using the **INFO** (information display) button  "Information display" (P. 103).



Single-frame playback information

Overall information







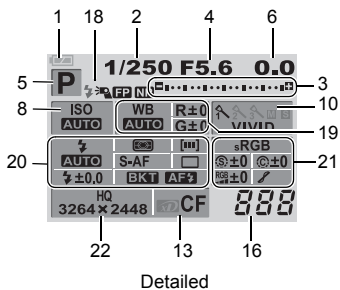
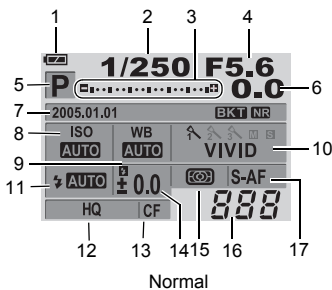





	Items	Indication examples	Ref. page
1	Battery check		-
2	Card	xD, CF	P. 26
3	Print reservation Number of prints	 ×10	P. 142
4	Protect		P. 114
5	Record mode	RAW, TIFF, SHQ, HQ, SQ	P. 31
6	Date and time	05.12. 23, 21:56	P. 138
7	File number Frame number	 100-0030 30	P. 103
8	AF frame		P. 69
9	Histogram		P. 104
10	Aperture value	F2.8	P. 41 - 45
11	Shutter speed	1/4000	P. 42 - 45
12	Exposure mode	<b>P, A, S, M</b> ,  ,  ,  ,  ,  ,  ,  , 	P. 34
13	Exposure compensation	0.7	P. 79
14	Focal length *	117mm	P. 210, 212
15	ISO	AUTO, ISO 100, ISO 200, ISO 400	P. 82
16	Metering mode	 ,  ,  , 	P. 77
17	Flash intensity control	0.5	P. 56
18	White balance	WB : AUTO	P. 87
19	Picture mode	 VIVID	P. 93
20	Color space	sRGB, Adobe RGB	P. 96
21	White balance compensation	R: +3, G: -2	P. 91

\* The focal length is displayed in 1 mm units.

## Control panel screen



	Items	Indication examples	Ref. page
1	Battery check		-
2	Shutter speed	1/2000	P. 42 - P. 45
3	Exposure compensation indicator		P. 80
	Exposure level indicator		P. 45
	Flash intensity level indicator		P. 56
4	Aperture value	F2.8	P. 41 - P. 45
5	Exposure mode	<b>AUTO, P, A, S, M,</b>	P. 34
6	Exposure compensation	+2.0	P. 79
7	Date/Time	'05.12.23, 21:56	P. 138
	Auto bracketing	<b>BKT</b>	P. 49
	Noise reduction	<b>NR</b>	P. 95
8	ISO	AUTO, 100, 200, 400	P. 82
9	White balance		P. 87
10	Picture mode	VIVID	P. 93
11	Flash mode		P. 53
12	Record mode	RAW+SHQ	P. 31
13	Card	xD, CF	P. 26
14	Flash intensity control	+2.0	P. 56
15	Metering mode	HI, SH	P. 77
16	Number of storable still pictures	135	-
17	Focus mode	S-AF	P. 70

	Items	Indication examples	Ref. page
18	Super FP flash Noise reduction	 <b>FP</b> <b>NR</b>	P. 60 P. 95
19	White balance White balance compensation	 R+3, G-2	P. 87 P. 91
20	Flash mode Flash intensity control Metering mode Focus mode AF frame Self-timer/Remote control/ Drive Auto bracketing AF illuminator	  +2.0  ,  <b>S-AF</b>   <b>BKT</b> <b>AF</b>	P. 53 P. 56 P. 77 P. 70 P. 69 P. 62 - 65 P. 49 P. 75
21	Color space Sharpness Contrast Saturation Gradation	sRGB, Adobe RGB  +2  +2  +2  H, L	P. 96 P. 93 P. 93 P. 93 P. 94
22	Record mode Resolution	RAW+SHQ 1280×960	P. 31

## Specifications

### ■ Product type

Product type	: Single-lens reflex digital camera with interchangeable lens system
Lens	: Zuiko Digital, Four Thirds System Lens
Lens mount	: Four Thirds mount
Equivalent focal length on a 35 mm film camera	: Approx. twice the focal length of the lens

### ■ Image pickup element

Product type	: 4/3 type full frame transfer primary color CCD
Total no. of pixels	: Approx. 8,880,000 pixels
No. of effective pixels	: Approx. 8,000,000 pixels
Screen size	: 17.3 mm (H) x 13.0 mm (V) (0.9" x 0.5")
Aspect ratio	: 1.33 (4 : 3)

### ■ Viewfinder

Product type	: Eye-level single-lens reflex viewfinder
Field of view	: Approx. 95% (for field of view on recorded images)
Viewfinder magnification	: Approx. 0.9x (-1 m <sup>-1</sup> , 50mm lens, infinity)
Eye point	: 10 mm (0.8") (-1 m <sup>-1</sup> )
Diopter adjustment range	: -3.0 - +1.0 m <sup>-1</sup>
Optical path fraction	: Quick return half mirror
Depth of field	: Can be checked with the  (one-touch WB) button (when PREVIEW registered)
Focusing screen	: Fixed
Eyecup	: Interchangeable

### ■ Monitor

Product type	: 2.5" TFT color LCD (Hyper crystal LCD)
Total no. of pixels	: Approx. 215,000 pixels

### ■ Shutter

Product type	: Computerized focal-plane shutter
Shutter	: 1/4000 - 60 sec Manual mode: Bulb (Limit: 8 min.)

### ■ Auto focus

Product type	: TTL phase-contrast detection system
Focusing point	: 3-point multiple AF (left, center, right)
AF luminance range	: EV 0 - EV 19
Selection of focusing point	: Auto, Optional
AF illuminator	: The built-in flash provides light. (light can also be provided by an external electronic flash.)

### ■ Exposure control

Metering system	: TTL full-aperture metering system <ol style="list-style-type: none"><li>(1) Digital ESP metering (49-segment multi pattern metering)</li><li>(2) Center weighted average metering (49-segment multi pattern metering)</li><li>(3) Spot metering (approx. 2% for the viewfinder screen)</li></ol>
Metering range	: (1) EV 1 - 20 (Digital ESP metering, Center weighted average metering) <ol style="list-style-type: none"><li>(2) EV 3 - 17 (Spot metering) (At normal temperature, 50 mm F2, ISO 100)</li></ol>



- Exposure mode : (1) AUTO: Full auto  
 (2) P: Program AE(Program shift can be performed)  
 (3) A: Aperture priority AE  
 (4) S: Shutter priority AE  
 (5) M: Manual
- ISO sensitivity : 100 - 400 (High ISO values (800 - 1600) are available)
- Exposure compensation : Exposure can be adjusted in 1/3, 1/2 or 1 EV step within a range of  $\pm 5$  EV.

### ■ White balance

- Product type : CCD
- Mode setting : Auto, Preset WB (7 settings), Customized WB , One-touch WB

### ■ Recording

- Memory : CF card (Compatible with Type I and II)  
 Microdrive (Compatible with FAT 32)  
 xD-Picture Card
- Recording system : Digital recording, TIFF (non-compression), JPEG (in accordance with Design rule for Camera File system (DCF)), RAW Data
- Applicable standards : Exif 2.2, Digital Print Order Format (DPOF), PRINT Image Matching III, PictBridge

### ■ Playback

- Playback mode : Single-frame playback, Close-up playback, Index display, Image rotation, Slideshow, Light box display, Calendar display
- Information display : Information display, Histogram display

### ■ Drive

- Drive mode : Single-frame shooting, Sequential shooting, Self-timer, Remote control
- Sequential shooting : 2.5 frames/sec. (Max. no. of storable sequential pictures: 4 frames in RAW/TIFF)
- Self-timer : Operation time: 12 sec., 2 sec.
- Optical remote control : Operation time: 2 sec., 0 sec. (instantaneous shooting) (RM-1 Remote Control (optional))

### ■ Flash

- Synchronization : Synchronized with the camera at 1/180 sec. or less
- Flash control mode : TTL-AUTO (TTL pre-flash mode), AUTO, MANUAL
- External flash attachment: Hot shoe

### ■ External connector

- USB connector/Multi-connector

### ■ Power supply

- Battery : BLM-1 Li-ion Battery x1/CR123A lithium battery x3 (for use with LBH-1 Lithium Battery Holder)

### ■ Dimensions/weight

- Dimensions : 129.5 mm (W) x 94.5 mm (H) x 66 mm (D) (5.1" x 3.7" x 2.6") (excluding protrusions)
- Weight : Approx.435 g (1.0 lb.) (without battery)

### ■ Operating environment

- Temperature : 0 - 40°C (32°F - 104°F) (operation/  
 -20 - 60°C (-4°F - 140°F) (storage)
- Humidity : 30 - 90 % (operation)/10 - 90 % (storage)

SPECIFICATIONS ARE SUBJECT TO CHANGE WITHOUT ANY NOTICE OR OBLIGATION ON THE PART OF THE MANUFACTURER.

# 13

## Accessories

This chapter describes how to use the accessories provided with your digital camera.

Provided accessories may differ depending on the camera kit. Although most accessories are optionally available, not all accessories are available in some areas.

- **BLM-1 Li-ion Battery / BCM-2 Li-ion Battery Charger**
- **LBH-1 Lithium Battery Holder**
- **ZUIKO DIGITAL interchangeable lenses**
  - ZUIKO DIGITAL 14-45mm f3.5-5.6**
  - ZUIKO DIGITAL 17.5-45mm f3.5-5.6**

## Charging the battery

- 1 Connect the power cord firmly to the battery charger.
- 2 Remove the protection cap and slide the battery into the charger as illustrated.

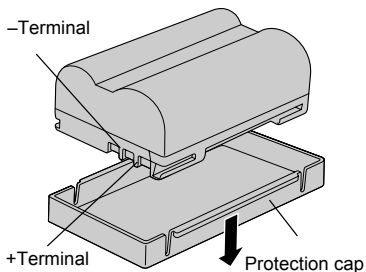

- 3 Connect the other end of the power cord firmly to a power outlet.

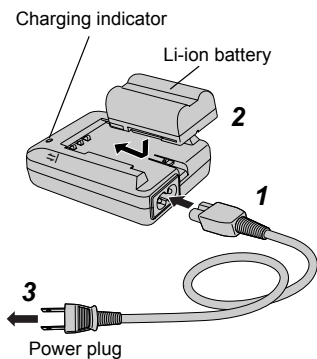

- 4 The charging indicator lights up and charging starts. Charging is completed when the indicator turns green. When charging is completed, unplug the power cord from the power outlet and then remove the battery from the battery charger.**



Charging indicator status	Charging status
Off	Battery is not connected.
Red lighting	Charging.
Green lighting	Charging completed.
Red blinking	Charging error (time-out, temperature error). *
Red lighting	Stand by for temperature protection.

\* In any of the following cases, unplug the power cord from the wall outlet and contact Olympus.

- Charging has not finished after 10 hours.
- The indicator blinks red even though the battery is inserted properly.

## Safety precautions

This instruction manual uses a variety of common symbols and icons to assist you in proper handling and usage of this product properly, and to warn you of potential hazards to yourself and others as well as to property. These symbols and their significance are described below.

 <b>DANGER</b>	Failure to observe the precautions indicated by this symbol may result in serious injury or death.
 <b>WARNING</b>	Failure to observe the precautions indicated by this symbol may result in injury or death.
 <b>CAUTION</b>	Failure to observe the precautions indicated by this symbol may result in injury or property damage.

### **DANGER**

- The BCM-2 Li-ion Battery Charger (hereinafter referred to as the “charger”) is designed for use with the BLM-1 Li-ion Battery (hereinafter referred to as the “battery”). Do not attempt to charge dry cell batteries and any other type of rechargeable battery. Doing so may cause fire, overheating, explosion or fluid leak.

- Do not short-circuit the battery terminals with a metallic object. When transporting or storing the battery, cover the battery terminals with the provided protection cap. It is dangerous to carry an uncapped battery in a bag, pocket, etc.
- Do not attempt to charge a battery that is damaged, leaking, or wet.
- If battery fluid gets in your eyes, blindness may result. Rinse your eyes with clean water without rubbing them and see a doctor immediately.
- Do not load a battery into the charger with the +/- terminals upside down. If the battery does not fit properly into the charger, do not force fit the battery. Doing so could cause a fire, overheating, explosion, fluid leak or other damage.
- Never solder the battery/charger, or attempt to repair, deform, modify or disassemble it.
- Never expose the battery/charger to water or moisture including rain, seawater and animal urine. Do not handle the battery/charger when it is wet or when your hands are wet. Do not use the battery/charger in damp or humid conditions (such as in a bathroom).
- Do not charge the battery or store the battery and charger in locations where they may be exposed to high temperatures. For example, do not leave it on the dashboard of a car under direct sunlight or place it near heating equipment.
- Keep the battery/charger out of reach of children. Swallowing a battery can be extremely dangerous. Should a child swallow a battery, see a doctor immediately.
- Do not use the battery/charger in a place where heat may build up, such as under a cushion.
- Never use the battery/charger around flammable gas. Otherwise, explosion or fire may result.
- Do not use the charger for any purpose other than to charge the specified batteries. For example, do not use as a DC power source.
- To avoid fire, overheating or electric shock, do not insert a metallic object such as a wire into the charger.
- Always power the charger with the voltage specified in the instruction manual.
- Do not use a power cord other than the one provided or one that is designated for use with this charger.
- Always insert the power plug completely and firmly into the outlet socket. Do not use the charger when the power plug is not fully inserted.

**⚠ WARNING**

- To avoid fire, overheating, explosion or leakage, do not subject the battery to excessive shock, throw it, or otherwise damage it.
- Never put the battery in a microwave oven or high-pressure container. This could cause a fire, leakage, overheating or an explosion.
- If the battery leaks or emits a burning odor, keep it away from heat sources. Leaked fluid may catch fire, causing the battery to smoke, burn or explode.
- If fluid from inside the battery sticks to your skin or clothes, it may cause injury. Wash it off immediately with clean water and see a doctor.
- If charging does not complete in the specified charge time, stop charging to prevent fire, overheating or explosion.
- When recycling or disposing of the battery, cover the battery with the provided cap (use tape to secure it) or use plastic tape to insulate all terminals. Otherwise, the batteries could be short-circuited and cause a fire, overheating or explosion.
- Do not touch the battery/charger during charging. Extended contact could result in minor burns.
- Do not use the charger if the charger, the power cord or the battery is damaged. To avoid electric shock or injury, never touch any internal parts that may have been exposed. If the charger or power cord is damaged, unplug the power cord and contact your nearest Olympus service center for repairs.
- If you notice any abnormalities such as leakage, discoloration, deformation, overheating, or odor, unplug the power cord immediately and stop using the charger. Continuing to use the charger under these conditions could result in fire, overheating or explosion. Contact your nearest Olympus Service Center for repairs.
- Keep the battery out of reach of children. To avoid electric shock or injury, children should not use the charger unless they are carefully supervised by a parent or guardian.

**⚠ CAUTION**

- Do not use the battery/charger with non-specified equipment.
- Do not continue charging for more than 24 hours. Fire, overheating, explosion or leakage may result.

- If charging does not complete although 10 hours have elapsed after the specified charge time, stop charging to avoid fire, overheating or explosion. In this case, contact Olympus Service Center.
- The battery gets hot after extended use in a camera. To prevent burns, do not remove the battery from the camera immediately after use.
- Do not place the battery on an unstable surface such as a tilted or unsteady table. If the battery falls off, it may be damaged or cause injury.
- Do not shake the charger with a battery in. The battery could fly out of the charger and cause injury or damage.
- Do not place a heavy object on the charger or power cord. Also do not use or store the charger or power cord in a location from which they might easily fall, such as on top of a TV.
- Do not store or use the charger where it may be exposed to moisture or excessive dust. Be sure to remove dust from the power plug before plugging it into a power outlet.
- Do not charge a battery in an extremely cold or hot environment. The optimum environmental temperature range when charging battery is between 10°C and 30°C (50°F and 86°F). Outside this range, a decrease in battery performance may result.
- Keep the power cord unplugged from a power outlet unless when using the charger.
- Do not pull on the cord when unplugging the power cord from a power outlet. Grasp the plug to remove it. Also do not bend or pull the cord excessively or place a heavy object on it. Damage to the power cord may result in fire, overheating or electric shock.

## Operating precautions

---

### ■ At time of purchase

- The battery is not charged at the factory. Charge it before use. Also, whenever the battery has not been used for a long period, recharge it before use.
- Check that the battery terminals are clean before use. If they are dirty, contact failure may cause problems with charging or shorten the battery's operation time after charging.

### ■ Care

- Clean the battery/charger and terminals by wiping them with a soft, dry cloth. Never use a wet cloth, alcohol, lacquer thinner, benzene or detergent.

**■ Operating temperatures**

- Use the battery within the operating temperature range specified for the camera.
- Even within the specified operating temperature range, battery operation time decreases as the temperature drops. When the temperature is low, it is recommended to carry a spare charged battery and keep it warm in a pocket, bag, etc. When carrying a battery in your pocket, be sure to cover the battery terminals with the provided protection cap to prevent short-circuiting. Do not put anything else in the pocket with the battery.
- The optimum ambient temperature for charging is between 10°C and 30°C (50°F and 86°F).
- When a battery is warm or hot, as is the case when it has recently been used, recharging may not be performed properly. For best results, wait until the battery temperature cools down before recharging it.

**■ Transport and storage**

- Do not leave the battery in the charger or camera. Even when the power switch is set to off, a small amount of current continues to flow and may lead to a decrease in battery performance. When not using the battery, attach the provided protection cap and store it in a cool, dry place with a temperature between 15°C and 25°C (59°F and 77°F).
- When transporting or storing the battery, attach the provided protection cap to prevent short-circuiting of the +/- terminals. Do not put any metallic objects including personal ornaments in a bag or drawer with the battery. This could cause a fire, overheating, explosion or leakage.

**■ Service life**

- Battery performance degrades gradually after repeated charging and discharging. When operation time has decreased significantly, you may need to replace the battery. Battery capacity is usually reduced by half after about 500 charge/discharge cycles (though this varies depending on the operating conditions).

**■ Recycling the battery**

- Please recycle batteries to help save our planet's resources. When you throw away dead batteries, be sure to cover their + and - terminals and always observe local laws and regulations.

**■ Notes on charging**

- The charger and the battery heat up during charging. This is not a malfunction.
- TV or radio reception may be interfered with during charging. This is not a malfunction. To avoid interference, move the battery charger further away from the TV or radio.



**■ Overseas use**

- To use the charger in another country, you may need a conversion plug that matches the design of the power outlets in that country. To find out what type of conversion plug or adapter is required, please consult a travel agent. Do not use an electronic transformer (travel converter) as this will cause malfunction.

**Main specifications****BLM-1 Li-ion Battery**

<b>Model Number</b>	: PS-BLM1
<b>Type</b>	: Rechargeable lithium ion battery
<b>Nominal output voltage</b>	: 7.2 V DC
<b>Nominal capacity</b>	: 1500mAh
<b>Charging/discharging count</b>	: Approx. 500 cycles. (Variable depending on the operating conditions.)
<b>Ambient temperatures</b>	: 0°C to 40°C (32°F to 104°F) for recharging, -10°C to 60°C (14°F to 140°F) for operation, -20°C to 35°C (-4°F to 95°F) for storage.
<b>Dimension</b>	: Approx. 39 (W) × 55 (D) × 21.5 (H) mm (1.5 × 2.2 × 0.8in)
<b>Weight</b>	: Approx. 75 g. (2.6 oz) (excluding the cap)

**BCM-2 Li-ion Battery Charger**

<b>Model Number</b>	: PS-BCM2
<b>Rated power input</b>	: 100 to 240 V AC (50/60 Hz)
<b>Rated power output</b>	: 8.35 V DC, 400 mA
<b>Charging time</b>	: Approx. 300 min. (Room temperature: with the BLM-1 battery)
<b>Ambient temperatures</b>	: 0°C to 40°C (32°F to 104°F) for operation, -20°C to 60°C (-4°F to 140°F) for storage.
<b>Dimensions</b>	: Approx. 62 (W) × 83 (D) × 26 (H) mm (2.4 × 3.3 × 1.0 in)
<b>Weight</b>	: Approx. 72 g (2 oz) (excluding the power cord)

**Design and specifications are subject to change without notice.**

# How to use the LBH-1 Lithium Battery Holder

You will need three CR123A Lithium batteries (commercially available).

**1** Remove the battery holder from its case.

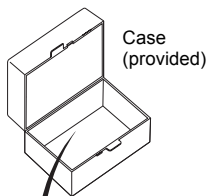

**2** Remove the holder cover while holding down the section indicated by the arrow in the illustration.

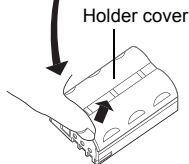

**3** Insert the batteries into the battery holder in the direction shown in the illustration.

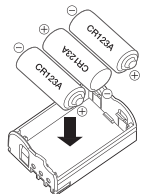

**4** Attach the holder cover to the battery holder as illustrated.

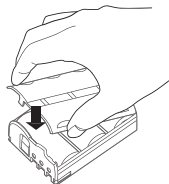

## ■ Available devices

- E-500, E-1, E-300 Digital cameras
- HLD-3 Power Battery Holder

## ■ Safety precautions

- Do not use the battery holder with non-specified equipment.
- When using the LBH-1 Lithium Battery Holder with a device in which more than one battery holder or battery can be loaded such as the HLD Power Battery Holder, do not use the BLM-1 Li-ion Battery at the same time.
- The CR123A Lithium Battery is not a rechargeable battery. Do not place the battery in a battery charger. Also, do not insert the battery into the battery holder with the +/- terminals upside down. Doing so could cause a fire or explosion.

- When carrying the battery holder with batteries loaded, be sure to put the battery holder in the provided case to prevent possible contact with other metallic objects that could cause short-circuiting. Also, make sure that no metal gets in between the batteries in the holder.
- Never heat the battery holder, put it in fire, or expose it to water or moisture. Doing so may cause fire or explosion.

### ■ Operating precautions

- When carrying or storing the battery holder with batteries loaded, be sure to put it in the provided case.
- Do not store the battery holder in places subject to high temperature (e.g. on a car dashboard, near heating equipment, etc.).
- When replacing the batteries, replace all batteries at the same time.
- Do not mix old batteries with new ones.
- Do not mix different brands or types of batteries.

### ■ Battery Precautions

- Use the batteries correctly. Incorrect usage of batteries could cause leakage, over-heating or other damage. When replacing batteries, make sure battery polarity ( (+) and (-) terminals) is correct.
- Never short-circuit, disassemble, recharge or throw the batteries into the fire. This may cause fire or explosion.
- Keep the batteries out of the reach of children. If a battery is swallowed by a child, contact a doctor immediately.
- Battery performance may drop temporarily in low temperatures. When using batteries outside in cold weather, keep the batteries warm by carrying them inside your clothes or in a bag or pocket. Even if performance has deteriorated in the cold, the batteries will recover once they have been returned to the normal temperature.
- If grease or sweat gets on the (+) or (-) terminal, a contact failure may result. Be sure to clean the terminals with a dry cloth before use.
- It is recommended to have fresh spare batteries available when going on an extended trip, especially when traveling abroad. Batteries may not be easily available in some areas.
- Pay attention to cautions printed on the battery.
- When disposing of dead batteries, always observe the laws and regulations regarding the disposal of such items.
- When not using the camera for an extended period of time, be sure to remove the batteries from the camera to avoid leakage. Store the batteries in a cool, dry location (around 20°C with low humidity).

### Main specifications

<b>Model Number</b>	: PS-LBH1
<b>Dimensions</b>	: Approx. 39 mm (W) x 55 mm (D) x 21.5 mm (H)
<b>Weight</b>	: Approx. 20 g (excluding case)

\* For the applicability of Olympus digital cameras, etc. to be released in the future, visit the Olympus website or contact Olympus customer support center.

## Safety precautions



Do not view the sun through the lens.

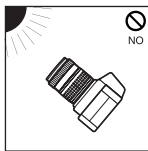

Do not point the camera lens at the sun. Sunlight will converge in the lens and focus inside the camera, possibly causing a malfunction or fire.

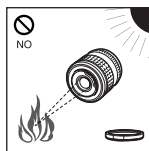

Do not leave the lens without the cap. If solar light is converged through the lens, a fire may result.

## Handling Precautions

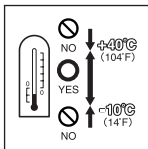

Working temperature range

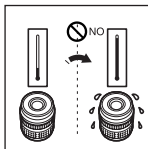

Abrupt temperature changes

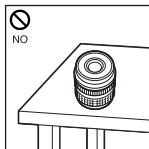

Do not put the lens with its contacts facing down.

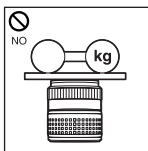

Too much pressure



Do not touch the lens.



Submergence



Do not touch the contacts.

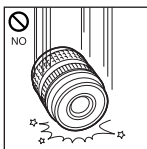

Do not drop

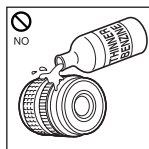

Organic solvents

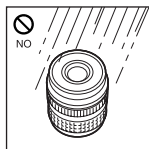

Excessive moisture



Magnetism

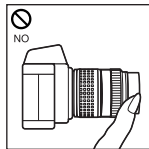

Do not hold the camera by the section of the lens extruded by the focusing operation.

## Storage Precautions



Cap the lens when it is not used.



Lens cleaning

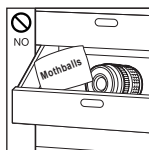

Moth repellents

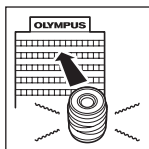

If you experience any problems, contact your nearest Olympus Service Center.

## ZUIKO DIGITAL 14-45mm f3.5-5.6

### ■ Main features

- The 14-45mm is a lens with high imaging capability, designed exclusively for use with Olympus FOUR THIRDS single-lens-reflex digital cameras.
- Standard zoom lens equivalent to a 28-90 mm zoom lens on a 35 mm film camera.
- Zoom lens with 12 elements in 10 groups including two aspherical elements.
- Can be used with the optional EC-14 teleconverter in manual focusing (MF) mode.
- Can be used with the optional EX-25 extension tube under the following conditions:

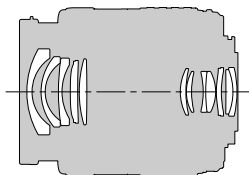

Lens configuration

Focal length	Focus adjustment	Working distance	Magnification ( ): Calculated based on 35 mm film camera
14mm	Shooting is not possible since subjects cannot be brought into focus at this focal length.		
25mm	MF	15.3cm - 15.7cm (6.0in - 6.2in)	0.99X - 1.14X (1.98X - 2.28X)
45mm	MF	20.8cm - 23.5cm (8.2in - 9.3in)	0.57X - 0.78X (1.14X - 1.56X)

### ⓘ Notes on Shooting

- Edges of pictures may be cut off if more than one filter is used or if a thick filter is used.

### ■ Nomenclature

- ① Hood mount section
- ② Filter mount thread
- ③ Zoom ring
- ④ Focus ring
- ⑤ Mount index
- ⑥ Electrical contacts
- ⑦ Front cap
- ⑧ Rear cap
- ⑨ Lens hood

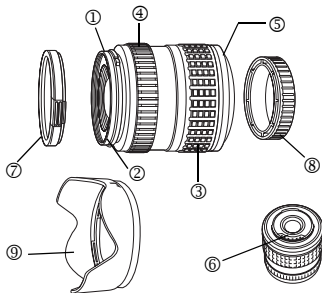

## ■ Attaching the hood

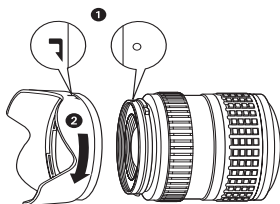

Use the hood when shooting a backlit subject.

## ■ Storing the hood

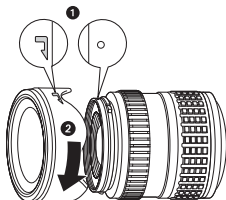

## Main Specifications

<b>Mount</b>	: Four Thirds Mount
<b>Focal distance</b>	: 14 - 45mm
<b>Max. aperture</b>	: f3.5 - 5.6
<b>Image angle</b>	: 75° - 27°
<b>Lens configuration</b>	: 10 groups, 12 lenses Multilayer film coating (partially single layered)
<b>Iris control</b>	: f3.5 - f22
<b>Shooting range</b>	: 0.38m (1.2ft) - ∞ (infinite)
<b>Focus adjustment</b>	: AF/MF switching
<b>Weight</b>	: 285g (10.1oz) (excluding hood and cap)
<b>Dimensions</b>	: Max. dia. $\phi$ 71 x Overall length 86.5mm (3.4in)
<b>Lens hood mount</b>	: Bayonet
<b>Filter mount thread diameter</b>	: 58mm

## ZUIKO DIGITAL 17.5-45mm f3.5-5.6

### ■ Main features

- The 17.5-45mm is a lens with high imaging capability, designed exclusively for use with Olympus FOUR THIRDS single-lens-reflex digital cameras.
- Standard zoom lens equivalent to a 35 - 90 mm zoom lens on a 35 mm film camera.
- Zoom lens with 7 elements in 7 groups including two aspherical elements.
- Can be used with the optional EC-14 teleconverter in manual focusing (MF) mode.
- Can be used with the optional EX-25 extension tube under the following conditions:

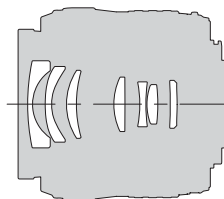

Focal distance	Focus adjustment	Working distance	Magnification ( ): Calculated based on 35 mm film camera
17.5mm	Shooting is not possible since subjects cannot be brought into focus at this focal length.		
28mm	MF	15.1cm - 15.9cm (5.9in - 6.3in)	0.89X - 1.16X (1.78X - 2.32X)
45mm	MF	18.4cm - 22.4cm (7.2in - 8.9in)	0.57X - 0.91X (1.14X - 1.82X)

### ⓘ Notes on Shooting

- When shooting with the focal length at 17.5 mm, "17 mm" is displayed on the monitor.



## ■ Nomenclature

- ① Rear cap
- ② Filter mount thread
- ③ Zoom ring
- ④ Focus ring
- ⑤ Mount index
- ⑥ Electrical contacts
- ⑦ Front cap

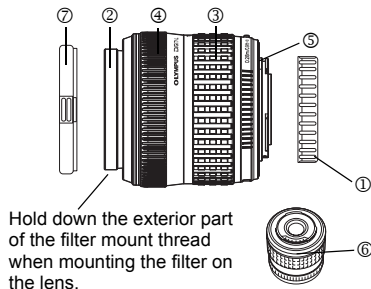

## Main Specifications

<b>Mount</b>	: Four Thirds Mount
<b>Focal distance</b>	: 17.5 - 45mm
<b>Max. aperture</b>	: f3.5 - 5.6
<b>Image angle</b>	: 63° - 27°
<b>Lens configuration</b>	: 7 groups, 7 lenses
<b>Iris control</b>	: f3.5 - f22
<b>Shooting range</b>	: 0.28m (1.2ft) - ∞ (infinite)
<b>Focus adjustment</b>	: AF/MF switching
<b>Weight</b>	: 210g (7.4oz) (excluding cap)
<b>Dimensions</b>	: Max. dia. $\phi$ 71 x Overall length 70.0 mm (2.8in)
<b>Filter mount thread diameter</b>	: 52mm

+	56
	69
	133
	78
	134, 146
	185
	138
	78
	134, 146
	79
	56
	128
	107
	135
	133
	184
	140
	29
	112
/Drive	62, 63, 65
	186
	106
	78
	183, 184
	126

4h TIMER	136
----------	-----

## A

Adobe RGB	96
AE BKT	83
AE lock	81
AEL METERING	123
AEL/AFL	121
AEL/AFL MEMO	123
AF ILLUMINATOR	75
AF MODE	70
ALL  (All WB compensation)	125
ANTI-SHOCK	96
Aperture priority shooting <b>A</b>	41
Auto bracketing	49
AUTO POP UP	126
Auto white balance	85
Auto-flash	50
Auto-focus	27

## B

Battery	199
Battery Charger	199
Battery Holder	206
BEACH & SNOW	38
BLACK & WHITE	110

Bulb shooting	46, 67
BUTTON TIMER	136

## C

C-AF	70
C-AF+MF	70
CANDLE	37
CARD SETUP	26
CF/xD	26
CHILDREN	36
CLEANING MODE	175
Close-up playback	99
COLOR SPACE	96
Color temperature	86
CompactFlash	26
Compression rate	30
COPY ALL	113
CTL PANEL COLOR	137
CUSTOM RESET SETTING	118
Custom white balance	89

## D

DIAL	127
Direct printing	145
DOCUMENTS	38
DPOF	140

## E

EDIT	110
EDIT FILENAME	132
EV STEP	123
Eyepiece cover	64

## F

FILE NAME	131
FIREWORKS	38
FIRMWARE	137
FL BKT	57
FLASH MODE	50
Flash off	52
Focus aid	73
Focus lock	27
Focus mode	70
FOCUS RING	129
FORMAT	26
Full-auto shooting AUTO	34

## G

GRADATION	94
-----------	----

## H

HIGH KEY	37
Histogram	104
HQ	29

- I**
- Index display..... 101
  - ISO..... 82
  - ISO BOOST..... 124
  - ISO LIMIT..... 124
  - ISO STEP..... 124
- J**
- JPEG/TIFF EDIT..... 109
- L**
- LANDSCAPE..... 35
  - LANDSCAPE+PORTRAIT..... 35
  - LOW KEY..... 37
- M**
- MACRO..... 37
  - MANUAL FLASH..... 52
  - Manual shooting **M**..... 45
  - METERING..... 77
  - MF..... 70
  - MF BKT..... 74
  - MY MODE SETUP..... 128
- N**
- NIGHT SCENE..... 36
  - NIGHT+PORTRAIT..... 36
  - NOISE REDUCTION..... 95
  - NTSC..... 135
  - Number of pixels..... 29
- O**
- OLYMPUS Master..... 154
  - One-touch white balance..... 90
- P**
- PAL..... 135
  - PictBridge..... 145
  - PICTURE MODE..... 93
  - PIXEL MAPPING..... 176
  - PORTRAIT..... 35
  - Preset white balance..... 85
  - Preview..... 47
  - PRIORITY SET..... 129
  - Program shift..... 40
  - Program shooting **P**..... 39
  - Protecting images..... 114
- Q**
- QUICK ERASE..... 130
- R**
- RAW EDIT..... 110
  - RAW+JPEG ERASE..... 130
  - REC VIEW..... 132
  - REDEYE FIX..... 111
  - Red-eye reduction flash..... 50
  - RELEASE PRIORITY C..... 75
  - RELEASE PRIORITY S..... 75
  - RESET LENS..... 129
- S**
- S-AF..... 70
  - S-AF+MF..... 70
  - SATURATION..... 111
  - Scene modes..... 35
  - SCREENS..... 137
  - SEPIA..... 111
  - Sequential shooting..... 62
  - SHADING COMP..... 94
  - SHQ..... 29
  - Shutter priority shooting **S**..... 43
  - Shutter speed..... 40
  - Single-frame erase..... 115
  - Single-frame playback..... 98
  - Single-frame shooting..... 62
  - SLEEP..... 133
  - Slow synchronization..... 50
  - SPORT..... 36
  - SQ..... 29
  - sRGB..... 96
  - STORAGE..... 134, 159
  - SUNSET..... 38
- T**
- TIFF..... 29, 109
- U**
- USB MODE..... 134
- V**
- VIDEO OUT..... 135
  - Viewfinder..... 192
- W**
- WB..... 91
  - WB BKT..... 92
  - WB compensation..... 91
  - White balance..... 85
- X**
- xD-Picture Card..... 26
- Z**
- ZUIKO DIGITAL..... 208

# OLYMPUS®

<http://www.olympus.com/>

## OLYMPUS IMAGING CORP.

Shinjuku Monolith, 3-1 Nishi-Shinjuku 2-chome, Shinjuku-ku, Tokyo, Japan

## OLYMPUS IMAGING AMERICA INC.

Two Corporate Center Drive, P.O. Box 9058, Melville, NY 11747-9058, U.S.A. Tel. 1-631-844-5000

### Technical Support (USA)

24/7 online automated help: <http://www.olympusamerica.com/E1>

Phone customer support: Tel. 1-800-260-1625 (Toll-free)

Our phone customer support is available from 8 am to 10 pm  
(Monday to Friday) ET

E-Mail: [e-slrpro@olympusamerica.com](mailto:e-slrpro@olympusamerica.com)

Olympus software updates can be obtained at: <http://www.olympus.com/digital>

## OLYMPUS IMAGING EUROPA GMBH

Premises: Wendenstrasse 14-18, 20097 Hamburg, Germany

Tel: +49 40-23 77 3-0 / Fax: +49 40-23 07 61

Goods delivery: Bredowstrasse 20, 22113 Hamburg, Germany

Letters: Postfach 10 49 08, 20034 Hamburg, Germany

### European Technical Customer Support:

Please visit our homepage <http://www.olympus-europa.com>

or call our TOLL FREE NUMBER\* : **00800 - 67 10 83 00**

for Austria, Belgium, Denmark, Finland, France, Germany, Italy, Luxemburg, Netherlands,  
Norway, Portugal, Spain, Sweden, Switzerland, United Kingdom

\* Please note some (mobile) phone services/provider do not permit access or request an  
additional prefix to +800 numbers.

For all not listed European Countries and in case that you can't get connected  
to the above mentioned number please make use of the following

CHARGED NUMBERS: **+49 180 5 - 67 10 83** or **+49 40 - 237 73 899**

Our Technical Customer Support is available from 9 am to 6 pm MET (Monday to Friday)